

NEW PRODUCT PREVIEW

A SAMPLE OF NEW PRODUCTS
SET TO DEBUT AT
FABTECH 2018

ATLANTA
NOV 6-8

REGISTER TODAY
FABTECHEXPO.COM

FABRICATING
TUBE & PIPE
STAMPING
FINISHING
WELDING

Advance

BENDING & FORMING
LASERS
CUTTING
AUTOMATION
ASSEMBLY
TOOL & DIE
PUNCHING
ROBOTICS

ACCELERATE YOUR
CAREER AND YOUR
BUSINESS AT
FABTECH 2018



FABTECH

NORTH AMERICA'S LARGEST METAL FORMING,
FABRICATING, WELDING AND FINISHING EVENT

Thank You to Our Platinum Sponsors





“10-bend part with acute side angles and narrow flanges, 800 parts per shift... Zero problems.”

— Matt Smith
Vice President of Sales



Matt Smith – VP Sales of NSA Industries (left) and Brian Poirier – Capital Engineer Manager

Complex Bending. Simplified Profit.

Founded in 1982, NSA Industries began as a 3-man shop building garden carts in St. Johnsbury, Vermont. Today, as the largest metal fabrication, machining, powder coating and assembly operation in New England, NSA employs 400 associates and operates five manufacturing facilities — serving as a contract manufacturer to a range of consumer and industrial customers.

As part of an ongoing commitment to invest in leading-edge technology and sustain consistent growth, NSA partnered with AMADA. NSA's Vice President of Sales, Matt Smith, comments on the decision to partner with AMADA, *“When customers see that we're invested in the finest technology available, they know that we're invested in their business. AMADA's Robotic Bending Systems enable NSA to process any lot size or part mix (for small and large parts) with optimal efficiency.”*



The HG 1003 ARs is designed to handle sheets up to 39" x 31" and the system's robot can support loads up to 44 lbs.

The EG 6013 AR eliminates the need for human operation and the associated risk of dealing with difficult-to-handle small parts.



HG 1003 ARs and EG 6013 AR Production-Enhancing Features:

- High-speed, high-precision, unmanned operation
- 7-axis bending robot
- Automatic tool changer and patented AMADA tooling
- Automated part sorting and stacking
- Ultra high-precision backgauge
- Automatic gripper changer
- Offline programming



Stay In Touch With What's Next.



FABTECH

BOOTH B6909

AMADA AMERICA, INC.

180 Amada Court • Schaumburg, IL 60173
www.amada.com/america

877-262-3287

Advance

ACCELERATE YOUR
CAREER AND YOUR
BUSINESS AT
FABTECH 2018

Whatever you need to advance and move forward, you'll find it here. Only FABTECH offers you direct access to the innovation, education and collaboration you can use to accelerate your career and your business.

REGISTER TO ATTEND TODAY AT FABTECHEXPO.COM

LEARN

Gain valuable, can't-miss insights from best-in-class education and training programs that target technical, operational and managerial segments.

CONNECT

Visionary keynotes, expert panels and other special events allow attendees to network with peers, exchange best practices and learn about the latest industry advancements.

COMPARE

Discover advanced technologies that improve quality and productivity, and compare innovative solutions from more than 1,500 exhibitors side-by-side.

FABTECH 2018 FEATURES

OVER 1,500 EXHIBITORS
KEYNOTE SPEAKERS
130+ EDUCATIONAL PROGRAMS

PRODUCT DEMONSTRATIONS
500+ NEW PRODUCTS
EXPERT-LED DISCUSSIONS

GEORGIA WORLD CONGRESS CENTER

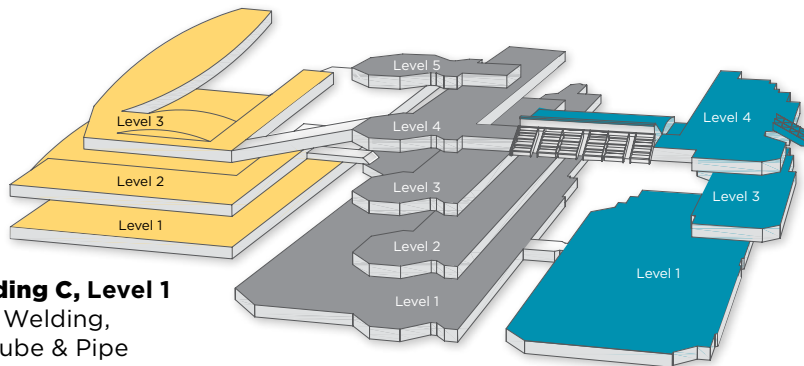

Building C, Level 1
Welding,
Tube & Pipe

Building B, Level 1
Fabricating, Finishing,
3D/Additive Manufacturing

Building A, Level 1
METALFORM,
Fabricating, Welding

TABLE OF CONTENTS

| | |
|--|--------------|
| General Show Information | 3-4 |
| Hotel & Travel | 4 |
| Exhibitor List | 6-8 |
| New Products | 9-32 |
| Additive Manufacturing/ 3D Printing/Rapid Prototyping | 9 |
| Arc Welding | 9 |
| Assembly | 9 |
| Bending/Forming | 9-10 |
| Coil Processing | 10 |
| Cutting | 10-11 |
| Finishing | 11-15 |
| Gases & Gas Equipment | 15 |
| Hydroforming | 15 |
| Inspection & Testing | 15 |
| Lasers | 15-17 |
| Maintenance & Repair | 17 |
| Material Handling/Marking | 18 |
| Metal Suppliers | 18 |
| Other Machinery/Equipment/ Parts/Products | 19-23 |
| Plate & Structural Fabricating | 23 |
| Press Brakes | 23-24 |
| Punching | 24 |
| Resistance Welding | 24 |
| Robotics | 24-26 |
| Safety & Environmental | 27 |
| Saws & Cut-off Machines | 27 |
| Software & Machine Controls | 27-28 |
| Stamping | 28 |
| Tool & Die | 28 |
| Tooling | 30 |
| Tube & Pipe Fabricating or Welding | 30-31 |
| Waterjet | 31 |
| Welding Consumables | 31 |
| Welding Machines/Equipment | 31-32 |
| Special Events | 34-35 |
| Education Program | |
| Schedule-At-A-Glance | 36-38 |

DESTINATION ATLANTA



Atlanta sits at the intersection of Southern charm, creativity and sophistication. From arts and culture to music and cuisine, the city offers something for everyone to enjoy. Around every corner is a new attraction, award-winning restaurant or neighborhood gem to explore.

GET THE BEST HOTEL SELECTION AND SAVINGS

Book your stay through onPeak, FABTECH's Official Hotel Provider, for guaranteed lowest rates and big benefits — including complimentary shuttle service, hotel parking and no booking or service fees! Reserve your rooms early for the best selection and price — hotels sell out quickly. Visit fabtechexpo.com/hotels.



DOWNLOAD THE FABTECH MOBILE APP

Download the FABTECH app to access show info on the go — exhibitor lists, a floor plan, sessions, agenda planner and more at fabtechexpo.com/mobile-app.

Sponsored By: 

START PLANNING TODAY!

SHOW ADMISSION

Exhibit-only attendance is **FREE** if you register by November 2, 2018. Beginning November 3, the cost to attend the exhibits is \$50. AWS, FMA, SME, PMA and CCAI members may always attend the exhibits for FREE with a valid member card.

HOW TO REGISTER

Register today online at fabtechexpo.com. Or, download a printer friendly registration form from the web site and fax to (508) 743-9696.

SHOW HOURS

Tuesday, November 6
10:00 AM – 6:00 PM

Wednesday, November 7
9:00 AM – 5:00 PM

Thursday, November 8
9:00 AM – 4:00 PM



COME SEE THE
KANO™ HD
IN ACTION AT
FABTECH
#B9443

**MORE THAN
A MACHINE.**

**A FABRICATOR'S
DREAM.**

When you purchase the KANO™ HD from Park Industries®, you're buying more than a great machine; you're buying a relationship. That's because we understand your business, your daily challenges and the need for responsive, real-time service. Since 1953, our in-house engineers, skilled technicians, dedicated trainers and world-class customer service teams have proudly brought American manufacturing ingenuity and world-class customer service to our customers. We promise to stand by you, through thick and thin, and be your trusted partner in productivity.

KANO™ HD unitized CNC cutting machines from Park Industries® deliver accuracy, productivity and reliability. Available in six machine sizes, KANO™ HD is configured with a Hypertherm EDGE® Connect CNC, a Hypertherm® high definition plasma system, an optional oxy-fuel cutting torch and your choice of cutting table style.



KANO™ HD

- TRUE UNITIZED DESIGN
- 6, 8 & 10 FT WIDE
- 12 & 24 FT LONG
- PLASMA & OXY-FUEL
- 3 CUTTING TABLE STYLES



// Contact us today to learn more about our unmatched service and support.
Dealer inquiries welcome.

800.328.2309 // parkindustries.com/kano

EXHIBITOR LIST (as of 8/23/18)

3D/ADDITIVE MANUFACTURING

3D Metal Printing Magazine
3D Systems
Additive Manufacturing
Advanced RP
Alpha Laser - US
Cincinnati Inc
Creafom
DisTech Automation Inc
EnvisionTEC Inc
Fusion3
Hyrel 3D
Laserline Inc
Markforged
Matterhackers
MicroCare Corporation
Nanograde Inc
Novatech
Oak Ridge National
Laboratory
Protolabs
Prototyping Solutions
Renishaw Inc
Shining 3d
SimuTech Group
SPI Lasers
Stacker LLC
Stratasys
SWECO
TriMech
TRUMPF Inc
TUV Rheinland
Ultimaker
Venton
Wisconsin Precision Casting
Corp
Xact Metal
Xometry

FINISHING

1st Source Products Inc/
Tycon Bearings
Accudraft Spray Booths
ACT Test Panels LLC
AFC Finishing Systems
Air Power Inc
AkzoNobel Powder Coatings
Alabama Washer & Oven Co
Alconox
Alexandria Metal Finishers
Alliance Manufacturing Inc
American Industrial Sales
LLC
Amiberica Inc
Andrea Team
APEL International
Argon Masking Corp
ASCO Carbon Dioxide Inc
Assured Testing Services
Atotech USA LLC
Axalta Coating Systems
AZZ Metal Coatings
Baril Coatings USA
BASF Corp
Bayco by Guspro Inc
BCI Surface Technologies
Bulk Chemicals Inc
BEKO Technologies
Bex Spray Nozzles
Blast Cleaning Technologies
Blast Services Inc
BlastOne
Burleigh Industries
BYK Additives &
Instruments, A member
of ALTANA
Calvary Industries Inc
Caplugs
Carlisle Fluid Technologies
Castrol
Catalytic Industrial Systems
CFCM Magazine
Chemetal US Inc
Chemical Coaters Assoc
International
Chemtec North America LLC
Circle-Proscio Inc
Clean Air Technology
Solutions
ClearClad Coatings LLC

FINISHING

Col-Met Engineered
Finishing Solutions
Columbus Industries Inc
Combustion and Systems
Inc
Cool Clean Technologies
LLC
Coral Chemical Co
CPR Systems
CTI Systems
Custom Fabricating &
Supplies
D&B Plating
Decoral System USA Corp
DeFelsko Corp
Deflin Industrial
Diamond H2O
Diamond Vogel - Industrial
Coatings
Dinamec Systems
DMP Corporation
DuBois Chemicals Inc
Duroair Technologies Inc
Dürr Systems, Inc.
DV Systems Inc
Dynabrade Inc
Echo Engineering
Eisenmann Corp
Elcometer Inc
EnviroServe Chemicals Inc
EPSI Engineered Products &
Services Inc
Ervin Industries
ESMA Incorporated
Euroimpianti Srl
Eurosider SAS Di Milli
Ottovio
FAMIS Incorporated
Fandeli Coated Abrasives
FANUC America Corp
Fischer Technology Inc
Flex Trim USA
Fostoria Process Equipment
div of TPI Corp
Frost Inc
Galv-Pro Products
GAT Finishing Systems
Gema USA Inc
General Fabrications Corp
George Koch Sons LLC
Global Finishing Solutions
GMA Industries Inc
Goff Inc
GPAINNOVA America Corp
Graco Inc
Graphic Products
HafoVac
Hammond Roto-Finish
Hedson Technologies North
America
Henkel Corp
Hentzen Coatings Inc
Heraeus Noblelight LLC
Herr Industrial Inc
Houghton International Inc
Hubbard-Hall Inc
IFS Coatings Inc
Infiniti Coating Solutions
INTEK Corporation
IntelliFinishing
International Thermal
Systems LLC
INTERTEK
Iowa Area Development
Group
IST America
IST International Surface
Technologies
IXS Coatings
Jackson Oven Supply
Jamestown Coating
Technologies
Jervis B Webb Co
Jessup Systems a division
of George Koch Sons
Keyland Polymer Material
Sciences LLC
Klinger Paint Co
LDPI Inc
LPI Inc
LS Industries Inc
Magick Rack/Production
Plus Corp

FINISHING

MAXAIR Systems
Michigan Metal Coatings Inc
Micron Fiber Tech
Midwest Finishing Systems
Mighty Hook Inc
Mighty Lube Systematic
Lubrication Inc
ML Filters
Mode Kartela Boya Ltd Stl
NikoTrack LLC
Nordic Air Filtration
Nordson Corp
Novacel
Omnirobotic
Parker Ionics
Patriot Metal Finishing
Systems Inc
Peening Technologies
PEM Inc
Pneu-Mech Systems Mfg
Pollution Control Products
Co
Polymer Molding Inc
Porcelain Enamel Institute
Inc
Powder Coated Tough
Powder Coating
Powder Coating Institute
Powder-X Coating Systems
LLC
PPG
Precision Color
PriceWalgren a division of
George Koch Sons
Products Finishing
Magazine
Prona Tools Inc
Raptor Blasting Systems
Richards-Wilcox Conveyor
Rohner
RollSeal Inc
S.E.F. ITALIA SRL
Sames Kremlin
Sata Spray Equipment
Scheugenpflug Inc
Selas Heat Technology
Sherwin-Williams
sia Abrasives
Sigma Abrasives North
America
Southern Equipment &
Services
Southern Fluid Systems
Spray Systems Inc
Spray Tech/Junair
Spraying Systems Co
Sprimag Automated Coating
Systems
SUNKISS-EPI Inc
System Technologies
Tanis Inc
TCI Powder Coatings
Technotrans America
The Electrocoat Association
Therma-Tron-X Inc
Transmet Corp
Trimac Industrial Systems
UniCure Spraybooths
Uni-Spray Systems Inc
V&S Galvanizing LLC
Valmont Coatings
Vapor Technologies
Viking Blast & Wash
Systems
Vitracoat America Inc
voestalpine eifeler coatings
VULKAN Blast Shot
W Abrasives
Wagner Systems Inc
Washington Mills Ceramics
Webb-Stiles Co

FORMING & FABRICATING

1st Source Products, Inc./
QTI Non-Sparking Tools
and Welding Tips
3D Fab Light Inc
3DCap Custom Headwear
Accu Tech USA
Accurate Technology Inc
Accurpress

FORMING & FABRICATING

Adira
Advance Cutting Systems
Advanced Process
Optimization Inc
AIM Inc
Ajan Elektronik Servis
Sanayi Ve Ticaret Ltd St
AKS Cutting Systems Inc
Akyapak Makina San Ve Tic
Ltd STI
Alabama Economic
Development (NAIDA)
Al-Fe Heat Treating Inc
Alliance For American
Manufacturing
Alliance Machine and
Engraving LLC
Allied Machine &
Engineering
Allied Powers LLC
Allor Manufacturing Inc/
Plesh Industries
Allstrap Steel & Poly
Strapping Systems
Alma CAM USA LLC
Almetals Inc
Alpha Precision Group
Alpha-Brush Aps
Alternative Parts Inc
AM Machinery Sales Inc
Amada America Inc
Amada Marvel Inc
Ambrell Induction Heating
Solutions
American Cutting Edge
American Photonics
American Punch Co
AMS Controls Inc
ANDRITZ Herr-Voss Stamco
Inc
Anhui Huatian Mechanic
Co Ltd
AP Laser
Apex Machine Group
Aptek Inc
Armstrong Kover Kwick Inc
Arro-Mark Co LLC
Arrowhead Manufacturers &
Fabricators Assoc
ASKO Inc
Athader
Atlanta Drive Systems Inc
ATS Applied Tech Systems
LLC
Autodesk Inc
Automated Layout
Technology
Automec Inc
AVEVA Inc
Barton International
Beagle I Inc
Beck Automation
Beckhoff Automation
Behringer Saws Inc
Beta Tools USA
Bentebender Manufacturing
Inc
Big Ass Fans
Big Steel Rack
Binder USA LP
Black Hills Corporation
Blastec Inc
Blue Water Engineering
Pty Ltd
Boeck Gmbh
BOFA Americas Inc
BOLDRINI
Bonak CPL SL
Bosch Rexroth Corp
Boschert Precision
Machinery Inc
Boss Laser
Boss Manufacturing Co
Bossi srl
Bowlin Manufacturing Inc
Bradbury Group Australia
Bradbury Group PuMa
Bradbury Metal Tile Roofing
Solutions
Braner USA Inc
BTM Company LLC
Buds Equipment Sales

FORMING & FABRICATING

Burghardt + Schmidt Group
Burnco Mfg Inc
Burr King Manufacturing Co
Bushman Equipment
Butech Bliss
BUWW Coverings Inc
Bystronic Inc
C Marshall Fabrication
Machinery Inc
C2AE Architecture +
Engineering
Camco
Cameron Mfg and Design
Camlock Systems Inc
Capital One
Carell Corporation
Carmel Group Inc
Caster Works Inc
CH Steel Solutions Inc
Chambrelan SAS
Changzhou City Wansui
Tools Works
Chase Cooling Systems
Chicago Slitter
CIDAN Machinery Inc
Cincinnati Inc
Cleveland Punch & Die Co
Cleveland Steel Tool Co
Closed Loop Recycling
CMF
CMS North America Inc
Coherent Inc
Coherent Inc
COLE-TUVE Inc
Combilift USA
COMEO Inc
Control Laser Corp
Control Works Inc
Controlled Automation Inc
Cortec Corp
Cosin Saws
Costa Sanders
Cowles Tool Co
CQT Kennedy LLC dba
Kennedy Manufacturing
CTD Machines
Custom Quality
Manufacturing
Custom Rollforming Corp
Cy Laser America
D Cooper Works
Daifo Seiki Co Ltd
Dake Corporation
Dalmec Inc
Darex LLC
DAVI Inc
DCM Tech Inc
Dees Hydraulic Industrial
Co Ltd
DeeTee Industries Ltd
Dener Makina San Tic
Ltd Sti
Design 2 Part
Design Storage & Handling
Inc
Diamond Saw Works Inc
Dimeco Coil Technologies
Inc
Dirinler Makina AS
Diversified Transportation
Services
DMC Metal Finishing
DoALL Sawing Products
Donaldson Torit - Donaldson
Company Inc
Dongguan Glorystar Laser
Technology Co Ltd
Dongguan Maozhong
Precision Hardware
Co Ltd
Doringer Cold Saws
Doucet Machineries Inc
Dr. Shrink Inc.
DropsA USA
Dude Solutions
Duo Robotic Solutions
Durma North America Inc/
Durmazlar/Durma
Dynex/Rivett Inc
Eagle Bending Machines Inc
Eastern Metal Supply
Ebbco Inc

FORMING & FABRICATING

ECI Software Solutions
Econco/CPi
Edgewater Fullscope
EHRT North America
ELG Metals Inc
Elumatec North America Inc
Emmegi USA Inc
EOS Business Surveillance
Solutions
Epcos Industrial Systems
LP
Epicor Software Corp
Epilog Laser Corp
EquipNet Inc
Ercolina - CML USA Inc
Ergo Advantage
Ergotronix
ERIEZ
ErmakUSA/Ermaksan
ERP & Scheduling Software
Euroboor USA
ExhibitForce
EXOR America
Eyeconic.TV
Fab Line Machinery Llc
Fab Supply Inc
Fabricating & Metalworking
Magazine
Fabricators & Manufacturers
Assoc Intl (FMA)
FabSuite LLC
Faccin USA Inc
Fagor Automation Corp
Fairmont Concepts
Family Business USA
FARO Technologies Inc
Fehr Warehouse Solutions
Inc
Felton Inc
FF Journal/Modern Metals
Ficep Corporation
Field Industries LLC
Fladder-Hansen & Hundebol
Inc
FlexArm Inc
Flow International Corp
Fluid Chillers Inc
Fluke Corporation
FormUSA
Formdrill USA Inc
Formtek Inc
Foshan Beyond Laser
Technology Co. Ltd
Freud Tools
Fromm Packaging Systems
Fujitsu Glovia Inc
Gasparini SpA
Gauer Metal Products Inc
GE Mathis Co
GenAlpha Technologies Inc
Genesis ERP
Glen Dimplex Thermal
Solutions
Global Shop Solutions
GMA Garnet
GMC Machine Tools Corp
Gorbel Inc
Greenfield Industries Inc
Guangzhou Kklaser Co Ltd
H2O JET Inc
Haas Automation Inc
Haco-Atlantic Inc
Haeger Inc
HAEUSLER AG Duggingen
Hafendorfer Machine Inc
Hangzhou Grand Imp & Exp
Co Ltd
Hangzhou Xiangsheng
Abrasive Machine
Manufacturing Co/AME
Hannsa Precision
Hans Weber Sales and
Service Corp
Harmonic Drive LLC
Hayes International
Heck Industries
HEM Inc
Hexagon Manufacturing
Intelligence
Hiwin Corporation
Hornet Cutting Systems
Hougen Manufacturing Inc

FORMING & FABRICATING

HUB Industrial
Husky Rack & Wire
Hyd-Mech Group Ltd
Hydren Systems LLC
Hymson Laser Intelligent
Equipment (Jiangsu)
Co Ltd
Hypertherm CAM
Hypertherm Inc
Hyster Co
igus Inc
II-VI INFRARED
IMSM Inc
Industrial Info Resources
Industrial Machine Trader
Industrial Machinery Digest
Industrial Magnetics Inc
InfoSight Corp
Innovative Components
Inovatech Engineering
Intro-N2 LLC
ISB
ITEQ Vietnam Co Ltd
Jaquet
Jepson Power Inc
JETCAM-NestONE Solutions
Jiangsu SUNSN Precision
Tool Technology Co Ltd
Jinan Bodor CNC Machine
Co Ltd
JMR Industrial
Johnson Bros Roll Forming
Co
Joseph Machine Company
JS Products
JWF Technologies
KAAST Machine Tools Inc
Kaka Industrial LLC
Kasto Inc
KB Duct - A CECO
ENVIRONMENTAL
COMPANY
KD Capital Equipment LLC
Keller USA Inc
Ken Bergman & Assoc LLC
Kennametal Inc
Kern Laser Systems
Keyedin
Keyence Corp of America
Kinetic Cutting Systems Inc
Kipp Inc
KMT Waterjet Systems Inc
KOHLER Maschinenbau
GmbH
Kolev Engineering Inc
Komatsu America Industries
LLC
LaCroix Precision Optics
Laguna Tools
Lantek Sheet Metal
Solutions
LAP Laser
Laser Research Optics
LaserStar Technologies Corp
Laservision USA
Lazer Safe Pty Ltd
Leasing Resources Inc
LENOX®
Levitte Technologies Inc
Lincoln Electric Co
Linemaster Switch Corp
LISSMAC Corp
Lockformer
LT Ultra Precision Optics
Lumentum
LVD Strippit
Machine Concepts Inc
MachineMetrics
Machinery Dealers National
Assoc
Made-In-China.Com
Manufacturing News
Manufacturing Solutions
Marion Die & Fixture Inc
Master Magnetics
Master Roll Manufacturing
Mate Precision Tooling
Mayer USA Inc
Mazak Optonics Corp
MB Metal Technologies LLC
MC Machinery Systems Inc
MCR Safety

Explore equipment and services from leading companies in the metal forming, fabricating, welding and finishing industries. Go to fabtechexpo.com for the most up-to-date exhibitor list.

FORMING & FABRICATING

MD Metals
MECCO
Meltric Corp
Memex Inc
Mesilla Valley Economic Development Alliance
Messer Cutting Systems
Mestek Machinery Inc
Metal Center News
Metal Supermarkets Service Company Inc
MetalFinish LLC
MetalForming Inc
Metalix CAD/CAM Ltd
MetaMation Inc
Metform International Ltd
Metsaw Systems Inc
Metreel Inc
MG Srl
Microsoft Dynamics 365 - Turnkey Technologies Inc
Midwest Automation
Midwest Tool Inc
MIE Solutions Inc
Modula
MPI Magnetic Products Inc
MultiCam Inc
Murata Machinery USA Inc
MVD Makina Sanayi A.S.
Nabtesco Motion Control Inc
Nadella Inc
Nano Purification Solutions
Nantong Reliant Trading Co Ltd
Neugart USA Corp
New London Engineering
Newport Corp
Nikola Labs
Nitto Kohki USA Inc
nLIGHT Inc
Nordfab Ducting
Norgren Automation Solutions LLC
Norlok Technology Inc
North Shore Steel
Nucor Buildings Group
Nucor Grating
Nukon USA
Oasis Scientific Inc
Ocean Machinery Inc
Oerlikon Metco (US) Inc
Ohio Laser LLC
OMAX Corp
OMCO
OmegaCube Technologies
Oncor
Orion Machinery North America Inc
Pacific Press Technologies
Packsize International LLC
Palmer Associates Inc
Pangborn
Pannier Corp
Paperboard Packaging Solutions
Paper-Less LLC
Park Industries
Parker Hannifin
Pat Mooney Saws
Patterson Fan Co
Peak Industrial
Peddinghaus Corp
PennEngineering
Pensa Labs
PEP Technology
Perfection Global LLC
Permadur Industries Inc
Peter Prinzing GmbH
Philpott Rubber/Lankhorst Mouldings
Phoenix Metals Co
Piranha
Pivatic Oy
Polyurethane Products Corp
Power Solutions Pro
Precision Saws Inc
Precitec Inc
Preco Inc
Premier Thermal Solutions
Prescor LLC
Press Brake Safety
Presto ECOA

FORMING & FABRICATING

Prima Power North America Inc
Project Tool & Die Inc
Pryor Technology
Qnect LLC
Quantum Machinery Group
R&M Manufacturing Co LLC
Radan
Radian Laser Systems
RAS Systems LLC
RDI Laser Blanking Systems
re:3D Inc
Red Bud Industries
Replacement Brush Tables
Revolution Machine Tools
Rhino Cutting Systems
Rice Lake Weighing Systems
Richardson Electronics Ltd
RIMCO Rotator
Rocklin Manufacturing Co
Rolled Alloys
Rolleri USA
Rollomatic Inc
Rose Graphix Inc
ROUND0
Rousseau Metal Inc
RWM Casters Co
Ryerson
SafanDarley BV
SafeRack LLC
Sahajanand Laser Technology LTD
Salvagnini America Inc
Samco Machinery Ltd
Sandmeyer Steel Co
Sawblade.Com
SB Whistler & Sons Inc
Schelling America Inc
Schmalz Inc
Schmidt
Schneeberger Inc
Schneider Electric
Scotchman Industries Inc
SDS/2
Sea Gate International Inc
Senfeng CNC & Laser Technology USA Inc
Service Lamp Corp
Shanghai Sheetwell Metal Manufacture Co Ltd
Shanghai Shuheng Cutlery & Mould Manufacturing Co Ltd
Shiv OM Brass Industry
ShopBot Tools Inc
ShopData Systems Inc
Shoptech
SIC Marking USA Inc
SigmaTEK Systems LLC
signode
Sinto America
Slatpro LLC
SMA Srl
Smart Manufacturing Hub
SME
Snap On Industrial
Soitaab USA Inc
Spanco Inc
SSAB
SSC Controls Co
SSI Schaefer
Stainless Shapes Inc
Stainless Structurals LLC
Starrett Company
State Of Texas
Staub Manufacturing Solutions
Steel King Industries Inc
Steel Storage Systems Inc
Stop-Painting.com
Striker Systems
STRUMIS LLC
SUNS International LLC
Surface Armor LLC
SYSPRO ERP Software
TAB Industries LLC
Tapeswitch Corporation
Team Texas
TECHNI Waterjet
Technical Translation Services

FORMING & FABRICATING

Texas Nameplate Co Inc
The Bradbury Group
The Fabricator Magazine
The M.K. Morse Company
Three D Metals Inc
Tie Down Engineering
TigerStop LLC
TIGER-VAC USA INC
Timesavers LLC
Tinius Olsen
Tormach LLC
Travelers Indemnity Company
Trilogy Machinery Inc
Trimble Solutions USA Inc.
Trim-Lok
TRUMPF Inc
TSI Inc
Tsunee America LLC
Tulip Interfaces Inc
TW Metals LLC
TYKMA Electro
Ungerer Technology Gmbh
United Lens Co
Up! LLC
Urrea Professional Tools
Ursviken Inc
US Industrial Machinery Co
Verisurf Software Inc
Virtek Vision International
VKS - Visual Knowledge Share
Voortman USA
VyTek
Walker Magnetics
WARDJet Inc
Water Jet Sweden AB
Waterjet Warehouse LLC
Weil Engineering North America
Weima America Inc
Welding Solutions Group
Welldone Environmental Protection Equipment Co Ltd
Welsler Inc
West Warwick Welding Co
Wila USA
Wilson Tool International
WM Caster
Workshops For Warriors
Wuko Inc
Wysong Parts & Service
Xinxiang Tianfeng Machinery Manufacture Co Ltd
Yarde Metals Inc
YESTOOL / Aloris USA

METALFORM

Accurate Die Design Software Inc/Logopress3
ADCO International Plastics Corporation
Agathon Machine Tools Inc
AIDA-America Corp
Allied Tool & Die Inc
Alma Machinery Co
Almco Inc
Alro Steel Corp
AP&T North America Inc
Apex Dynamics USA
Arkansas Tool & Die Inc
ART Metals Group
ASC Machine Tools Inc
Associated Spring Raymond
Atlas Machine & Supply Inc
AutoForm Engineering USA Inc
Automated Tapping Systems
Azimuth Machinery
Bad Dog Tools
Balluff Inc
Beckwood Press Co
Berg & Co GmbH
Spanntechnik
Bestar LLC
BesTech Tool Corp
Bihler 4 Slide-NC
Brown Boggs Machine Co
Bruderer Machinery Inc
BTD Tool & Die

METALFORM

Century Fasteners Corp
China Machinery Industry Engineering (Dalian) Co Ltd
CIECO Inc
Clairon Metals Corp
COE Press Equipment Corporation
Colt Automation LTD
Concraft Holding Co Ltd
Dallas Industries Inc
DAYTON Lamina Corporation
DDI Inc
Delta Computer Systems Inc
Delta Industrial
DESCH Canada Ltd
Die Cad Group Inc
DieTronic
Dixie Industrial Finishing Co Inc
Dongguan Blacksmith Tool Co Ltd
Dongguan Changhong Metal Technology Co LTD
Dongguan Gooming Mechanical Co Ltd
Dongguan Lelin Tilledtek Metal Technology Co. Ltd.
Dongguan Shuang Shun Precision Mold Co Ltd
Dongguan SS JMP Tooling Co Ltd
Dongguan SYH Tooling Co Ltd
Dongguan Tai Qun Hardware Technology Ltd.
Dongguan Vision Tool & Mould Co Ltd
Dongguan Zerostart-tool Co Ltd
DOP Precision Tool & Die
DriveSpec International LLC
DTC Products Inc
Dubuque Stamping & Mfg Inc
Durable Superior Casters
Eagle Metals
Eagle Press & Equipment Co Ltd
EAS Mold & Die Change Systems Inc
EBWAY LLC
EIGEN
Elizabeth Carbide Components
Engineered Lubricants Co
Enrotech Industrial Technologies
Erickson Metals Corp
ESI North America
Excelsior Hardware & Plastic Co Ltd
F&G Tool and Die Co
Fagor Arrasate
Falcon Tool Company
Feed Lease Corp
Fibro Inc
Fidelity Inspection Fixture Manufacture Co Ltd
FluidForming Americas
Fontjine Grotnes Inc
Forming Technologies Inc
FORMTEK-ME
Foshan Ouyiqing Metal Product Co Ltd
Fuchs Lubricants Co
GH Tool and Die Co Ltd
Gibbs
Goanwin USA Inc
Green Valley Manufacturing Inc
Greenerd Press & Machine Company Inc
Gruber Tool & Die Inc
Guangdong TopZone Tooling Co Ltd
Guangzhou Rainbow Metal Spring Co Ltd
Güdel
Helm Instrument Co Inc
Hilma
Hitachi Metals America

METALFORM

Hong Kai Precision Metal Stamping Tool and Product Co LTD
Hutchison Tool Sales Co
IHI Ionbond Inc
Industrial Innovations Inc
IQMS
Jarvis Cutting Tools
JD Norman Industries
JET-SET
Ji' An RuiPengFei Precision Technology Co. Ltd
Jiangsu Bojun Industrial Technology Co Ltd
JIER North America
JIT Automation Inc
J-Tech
Kaeser Compressors Inc
Kai He Machinery Co Ltd
KEL Precision Products Inc
Komatsu America Industries LLC
Kosmek USA
Kunshan Eagle Precision Tooling Co Ltd
Larson Tool & Stamping
Latrobe Specialty Metals Distribution
Lee Contracting Inc
Linco Precision Industrial Co Ltd
Linear Transfer Automation Inc
Link Electric & Safety Control
Logopress3/Accurate Die Design Software Inc
LSP Industries Inc
Lucky Harvest Co Ltd
Macrodyn Technologies Inc
Magnum Press Inc
Mayfran International Inc
Meusburger US Inc
Midwest Industrial Metals
MJC Engineering & Technology Inc
Moeller Precision Tool
Mollificio Bordignon srl
MPP
Multipress Inc
Neff Press Inc
Nidec Minster Corp
Ningbo Hifly Tool Technology Co Ltd
Nissan
NKS LLC
NN Inc Precision Products Group
NOXON Automation USA LLC
Oneda Corporation
Oriimec Corporation of America
Orttech Inc
Overton Industries
P/A Industries Inc
Pacesetter Systems
Pascal Engineering Inc
Paulo
Pax Products Inc
Penn United Technologies Inc
Plant Engineering Services Inc
Plex Systems
PMF Industries Inc
Purfer Precision Products
Pottiez America LP
Precious Plate Inc
Precision Metalforming Association
Precision Punch Corp
Precision Steel Warehouse Inc
Press Room Equipment Co
Pressroom Electronics Inc
PrimeTest Automation Inc
Pronic Inc
Qingdao Merid Machinery Co Ltd
Quintus Technologies AB
Ramcel Precision Stamping and Manufacturing LLC

METALFORM

Raziol Zibulla & Sohn GmbH
Ready Technology Inc
Right Corner of Texas
Rigidized Metals Corp
Rock Valley Oil & Chemical Co Inc
Rockford Systems LLC
Rolled Metal Products
Roller Die + Forming Co
Ross Controls
RUF Briquetting Systems
Samson Roll Formed Products Co
Sander Automation Corp
Sangiaco Presses Americas LLC
Sankyo Automation
Sasahara Kanagata Co Ltd
Scientific Forming Technologies Corp
SelfLube
Serapid Inc
SEVI America Inc
Shenzhen HuaYuanDa Technology Co Ltd
Shenzhen Powstar Technology Ltd
Shenzhen Yalu Industry Co Ltd
Shenzhen Zhuotai Precision Tooling
ShopEdge Software Inc
SIMPAC America Co Ltd
Solar Atmospheres
Soph Inc
Southern Machinery Repair Inc
Special Springs LLC
Stamtec Inc
Superior Die Set Corp
TDS Automation - A Doerfer Company
Tecnomagnete Inc
The Heim Group
Theta TTS Inc
Toledo Integrated Systems
Torque Inc
Torque Technologies Inc
Torspec International LLC
Tower Metalworking Fluids
TOX Pressotechnik LLC
Trans-Matic
Tribco Inc
Triple Crown Products
T-Sim Solutions
TST Tooling Software Technology LLC
TURCK Inc
Uddeholm USA
Uelner Precision Tools & Dies
Ulbrich Stainless Steels & Special Metals Inc
Unico Inc
Unisorb Installation Technologies
Unist Inc
United Aluminum Corp
United Machine Corp
United Performance Metals
Versatility Professional Tool Storage LLC
Vibro/Dynamics LLC
Victory Tool
Vidir
Voith Turbo Inc
Wilson Tool International
Wintriss Controls Group LLC
WorkWise Software
World Precise Machinery Co Ltd
Wuxi Minghao Automotive Parts Co Ltd
Xinyongxu Metal & Die (Shenzhen) Co Ltd
xTuple — Open Source ERP+CRM + Web Portal
Yih Shen Machinery Co Ltd
Yong Da Precision Mould (Dongguan) Co Ltd
Zapp Precision Strip
Zerust Corrosion Solutions
Zwick USA

TUBE & PIPE

5 Star Engineering and Maintenance
Accurex Measurement Inc
Addition Manufacturing Technologies
Advanced Tubular Technologies Inc
Ajax Tocco Magnethermic Corp
Alpine Bender Machinery
AMOB SA
Bend Tech
BLM Group USA Corp
CEIA USA Induction Heating Systems
Chang Yee Steel Co Ltd
Chiyoda Kogyo-Maruka USA
Clark Fixture Technologies
Comblift USA
Comco USA Inc
Copier Bevel Machines
Cornerstone Capital Partners
Creative Safety Supply
Crippa SPA
Crum Manufacturing Inc
Current Tech
Dynobend BV
Electrex Industrial Solutions
ESCO Tool Co
FD Machinery
Fenn
FIT RITE Systems LLC
G.B.C. Industrial Tools S.p.A.
Gem Tool Corporation
George A Mitchell Co
GFU Maschinenbau GmbH
GH Induction Atmospheres LLC
Guild International
Han Jie Machinery Co Ltd
Hangzhou Wagen Precision Tooling Co Ltd
Haven Manufacturing Corp
Herber Engineering AB
HGG Profiling Equipment BV
Horn Machine Tools Inc
Huth Ben Pearson
International LLC
Industrial Solutions & Innovation LLC
Innerspec Technologies
INNOVO Corp
Inserpetrol LLC
International Tube Association
IP Automation
Italian Trade Agency
ITEC - Innovative Tube Equipment Corporation
J&S Machine Inc
Kent Corp
Krais Tube Expanders
Lilbacka USA
LINSINGER
Manchester Tool & Die Inc
Matter Srl
Metronor Inc
Mill Masters
Nantong Reliant Trading Co Ltd
New-Form Tools
Newalliance Inc
OMCG Inc
OMNI-X USA
Origin Technologies Corp
Overton Industries
Passline Performance
PHI
Pillar Induction
Pines Engineering
Proto-1 Manufacturing
Pypeserver Inc
Quaker Chemical Corporation
REA JET US
Revolution Machine Tools
RF System Lab
Roll Machining Technologies & Solutions
Saar Hartmetall USA LLC
SAET Emmedi
Schwarze-Robitec GmbH

TUBE & PIPE

SciAps Inc
Shaw Stainless & Alloy
Sonha SSP Vietnam Sole
Member Co Ltd
Star Technology S.r.l
T&H Lemont
T-Drill Industries Inc
Tenryu America Inc
Thermatool Corp
Thermo Fisher Scientific
Tools for Bending
Transfluid Maschinenbau
GmbH
TRUMPF Inc
Tube & Pipe Technology
Magazine
Tube Bending Concepts Inc
Tube Form Solutions
Tubex Technology
Machinery
Ultraflex Power
Technologies Corp
Unison LTD
Universal Controls Group
Universal Tool & Engineering
Universal Tube & Rollform
Equipment Corp
Vulcan Tool Corp
WAFIOS Machinery Corp
Wauseon Machine &
Manufacturing Inc
Winton Machine Company
World Machinery & Saw Inc
YLM USA Inc
Yulcon Korea & Mexico

WELDING

3M
ABB Inc
Abicor Binzel
Abracol North America Corp
Accuracy Machine
Ace Industrial Products
Advantage Materials Inc
AGT Robotics
Aimchamp Abrasives
Aimtek Inc
Air Cleaning Specialists Inc
Air Purification Inc
Airgas Inc
Alabama Laser
Allegro Industries
Alliance Specialties and
Laser Sales
Allied Powers LLC
ALM Positioners Inc
ALS Maverick Testing
Laboratories Inc
Alumareel
American Society For
Nondestructive Testing
American Technical
Publishers
American Torch Tip Co Inc
American Welding Society
American Weldquip LLC
AMET Inc
Anand Arc Ltd
Andersen Industries Inc
ANDRITZ Soutec AG
Anthony Welded Products Inc
Antra Technologies Co Ltd
Anxin Abrasives Co Ltd
Applied Technical Services
Inc
AquaSol Corp
Arc Machines Inc
Arc Products - A Lincoln
Electric Co
ARC Specialties Inc
Arcos Industries
Artotic
Astro Arc Polysoude Inc
Astrolite Alloys
ATI Industrial Automation
ATOP China Welding
Products Co Ltd
Atollo Lift
Auburn Manufacturing Inc
Automatic Welding Wire
Company Inc
Aviva Metals
AVS Industries LLC
AWS Bookstore
AWS Careers in Welding
Trailer
AXXAIR USA
B&B Pipe & Industrial Tool

WELDING

Baoji Taiimei New Material
Technology Co Ltd
Bar None Pipeline Services
LLC
Becken Technology
Development Limited
Beijing Essen Welding &
Cutting Fair
Beijing Metals & Minerals
Corp
Bernard
BESSEY Tools North America
Beveler USA Inc
Black Stallion
Bluco Corp
Blue Demon Welding
Products
Bolhoff USA
Bonal Technologies Inc
Bradford Derustit Corp
Braeuer Systems America
Bruker Corporation
Buffalo Shrink Wrap
BUG-0 Systems
Burny
Butler Weldments Corp
C & A Automation Inc
Cambridge Vacuum
Engineering
CANTESCO®
Capital Machine
Technologies Inc
Capital Weld Cleaners
Carr Lane Manufacturing Co
Caster Master
CEI Welding Software
CENIT North America Inc
Cerbaco Ltd
CGW-Camel Grinding Wheels
USA
Changzhou Asia Science &
Technology Co Ltd
Changzhou Huarui Welding &
Cutting Machinery Co Ltd
Changzhou Shine Science &
Technology Co Ltd
Changzhou Zhengyang
Welding Material Co Ltd
Chart Inc
Cheap MoveZ LLC
Chicago Pneumatic Tool Co
China National Silk Imp &
Exp Wuxi Corp Ltd
Cibo NV
CK Worldwide
Clamptek USA Inc.
Clean Air America
CleanSpace Technology
Pty Ltd
Clearway
Cloos Robotic Welding Inc
COB Industries Inc
Cold Jet
Coldwater Machine Co
Computers Unlimited
Convergent Photonics
Coral SPA
Corimpex SRL
COR-MET INC
Cougartron Inc
Coxreels Inc
CS Unitec Inc
CVI Technology
D/F Machine Specialties Inc
Dakota Ultrasonics
Dataweld Inc
Dedeco International Inc
Dengensha America Corp
Denray Machine Inc
Dentec Safety Specialists
Diagraph MSP an ITW
Company
Diamond Ground Products
Inc
Dino-Lite Scopes (BigC)
Dinse Inc
Direct Wire & Cable
Directitech
Dravhtwerk Elisental GmbH
& Co
DualDraw LLC
Dyna Torque Technologies
Inc
Dynatorch Inc
Easom Automation - A
Lincoln Electric Co
EASYSKleen Pty Ltd
EH Wachs/Orbitalum

WELDING

Eidos Ergonomics
Ekide SL
Elcometer Inc
eldec LLC
Electron Beam Technologies
Inc
EnergyTech Inc
Enstiech Inc
ESAB Welding & Cutting
Products
ESTA Extraction USA
Eurovac
FANUC America Corp
Fastenal Company
Fein Power Tools Inc
Fenotech
Ferris State University
Filter 1
Fireball Tool
Flame Technologies Inc
Flange Wizard Inc
FlashCut CNC
FlexArm Inc
Flexovit USA Inc
FOCUS GmbH
Forney Industries Inc
Fronius USA LLC
Fusion Inc
G&J Hall Tools Inc
Ganzhou Hongfei Tungsten
& Molybdenum Materials
Co LTD
GAWDA
Genesis Systems Group
Genstar Technologies Inc
GMTA - German Machine
Tools of America
Golden Eagle Minmetals
(Beijing) Wldg Materials Co
Goss Inc
GSM America Inc
Gudel Inc
Gullico International
Hangzhou Xcan Saw Co Ltd
Hankook Weldtek Co Ltd
Harbach Fit Up Gear
Harbert's Products Inc/Allied
Flux Reclaiming Ltd
Hardface Technologies by
Postle
Harris Products Group
Hascor USA Inc
HBS Stud Welding Partners
Henan Huamao Metal
Materials Co Ltd
Heron Intelligent Equipment
Co Ltd
HKS Prozesstechnik GmbH
Hobart Brothers
Hobart Institute of Welding
Technology
Huber Supply
Hypertherm Inc
IAP Air Products
Ideal Welding Systems LP
igm Robotic Systems Inc
II-VI HIGHYAG
Imperial Systems Inc
International Welding
Technologies Inc
InterTest
IPG Photonics
Ironworker Management
Progressive Action
Cooperative Trust
Itec Mfg LLC
IVEC Systems
JASIC Technologies America
Inc
JAZ USA Inc
Jiangsu Meixin
Optoelectronics
Technology Co Ltd
Jiangxi Guangxin New
Material Co Ltd
JLC Electromet Pvt LLC
John Tillman Co
Joysun Abrasives Co Ltd
JR Automation
Kalas Wire Inc
Kawasaki Robotics (USA) Inc
Kayo Products Co Ltd
KeepTheHeat
Kemper America Inc
Kent Stud Welding Co Ltd
Kim Tin Investment
Corporation

WELDING

Kistler Cutting and Welding
(Kistler GmbH)
KLINGSPOOR Abrasives Inc
Kobelco Welding of America
Inc
Koike Aronson Inc
Kooben Technology USA Inc
KUKA Robotics Corporation
LA-CO Industries Inc
Laizhou Hongyuan Bench
Vise Manufacture Co Ltd
Laser Mechanisms Inc
Laserline LLC
LeTourneau University
Lianyungang Orientcraft
Abrasives Co Ltd
Liburdi Automation Inc
LinAn Da Yang Welding
Material Co Ltd
Lincoln Electric Co
Luvata Ohio Inc
Machitech Automation LLC
Magnatech LLC
Magnum Reels
MAGSWITCH Technology Inc
Manufacturing Solutions
Industries Inc
Matsumoto US Technologies
Inc
Matuschek Welding Products
Inc
MAXAIR Systems
McDantim Inc
Mercer Industries
Meridian Laboratory Inc
Metabo Corp
Michigan Pneumatic Tool Inc
Micro Air
Midalloy
Miller Electric Mfg Co
Millner-Haufen Tool Company
MITUSA Inc
MK Products Inc
Morris Precision Technology
Company Limited
MTA-USA LLC
Murrplastik Systems Inc
NASA Technology Transfer
Program
Nasarc Technologies
Nation Wide Products
National Standard
Nederman LLC
Nelson Stud Welding Inc
New Fire Co Ltd
New Spool Srl
Newland (Tianjin) Welding
Material Co Ltd
Niifisk Inc
Ningbo Aibo Tools Co Ltd
Ningbo Janson Machinery
Ningbo Kimpin Industrial
Pte Ltd
Ningbo Powerway Alloy
Material Co Ltd
Ningbo Starx Welding &
Cutting Tech Technologies
Ningbo Zehen International
Trade Co Ltd
Nissan
Nodha Industrial Technology
Wuxi Co. Ltd
NOMMA
Norton I Saint-Gobain
Novarc Technologies Inc
NSRW
Nu-Tec Systems
Octopuz Inc
Olympus
Optrel Inc
Orbitalum
Osborn
OTC DAIHEN Inc
OTTO Arc Systems Inc
Oxylance Inc
Pador Marketing Group
Panasonic Factory Solutions
Company of America
Pandjiris Inc
Parweld Ltd
PDS Bartech Inc
Pearl Abrasive Co
Pemamek LLC
Pennsylvania College of
Technology
PFFERD Inc
Phoenix International Inc

WELDING

Plasma Automation Inc/Vicon
Machinery LLC
plasma USA LLC
Polymet Corp
Praxair Inc
Preco Inc
Preston-Eastin Inc
Primax Mfg & Trading Inc/
Caiman Gloves
Pro Spot International
ProArc USA
proAutomation LLC
Proceq USA Inc
Production Products Inc
PROFAX / LENCO
PTR-Precision Technologies
Inc
PureFlo
PushCorp Inc
PythonX - A Lincoln Electric
Co
Qingdao Kingdom Cheer
Industry Co LTD
Radyne Corp
Rasco FR
Resistance Welding Machine
& Accessory
Rex-Cut Abrasives
Rhodius USA LP / Beveltools
RIDGID
Rite Hite Machine Guarding
Robotic Automation
Robotic Technologies of
Tennessee LLC
Robotmaster
RoboVent
Roda Specialty Steel Inc
RoMan Manufacturing Inc
RPB Safety LLC
RWMA - Resistance Welding
Manufacturing Alliance
Saf-T-Cart Inc
Sandvik Materials
Technology (Formerly)
Sanpo Publications
Incorporated
SanRex Corporation
Scrape-N-Burr
Seedorff Acme Corp
Seit Electronica
Select Arc Inc
Servo-Robot Inc
Shandong Aotai Electric
Co Ltd
Shandong Juli Welding
Co LTD
Shanghai Binic Industrial
Co Ltd
Shanghai TAYOR Heavy
Industry (Group) Co Ltd
Shenzhen Action Welding
Technology Co Ltd
Shenzhen Donrun Welding
Equipment Co Ltd
Sideros Engineering Srl
Simufact Engineering
SMA Abrasives USA LLC
SMC Corporation of America
Southern Copper & Supply
Southern Stud Weld Inc
SPECTRO Analytical
Instruments
Standard Resistance
Welder Co
Stanley Black & Decker Inc
State Of Texas
Steel Vision Tools
Steelmix Tools
Steiner Industries
Strong Hand Tools
Strong Hold
STUAA Automation (Qingdao)
Co Ltd
Suhner Industrial Products
Inc
Sumig Usa Corp
Sunmer Manufacturing Co
Sunstone Welders
SuperFlash Compressed Gas
Equipment
Superior Abrasives LLC
SureWex
Surface Engineering Alloy Co
T. J. Snow Company
Taylor-Winfield Technologies
Inc
TEAC America Inc

WELDING

Team Industries Inc
TEC Welding Products
Techflex Inc
Techniweld USA
TECMEN Electronics Co Ltd
Tempest Air
Tennessee Rand Inc - A
Lincoln Electric Co
Tersura Abrasives Co Ltd
The Plastic Forming Co
THE ROUECHE CO LLC
Thermacut Inc
Thermal Dynamics
Tip Tig USA LLC
Top Cat Air Tools
Torchmate - A Lincoln
Electric Co
Trafimet Group S.p.a.
Tregaskiss
Trendex Information Systems
Inc
Tri Tool Inc
TRU-FIT Products TRU-Weld
Trystar Inc
TURCK Inc
TWI North America LLC
Tyrolit Industrial Abrasives
UltraTech International Inc
U-Mark Inc
Uneda Enterprises Inc
United Abrasives Inc /SAIT
Universal Robots USA Inc
Uniweld Products Inc
Upstate SC Alliance
Uweld Technologies Co Ltd
VDM Metals USA LLC
VERNON Tool - A Lincoln
Electric Co
Victory Plasma Systems
Viega
Vitronic Machine Vision
Vizient Manufacturing
Solutions Inc - A Lincoln
Electric Co
VSM Abrasives Corp
Walter Surface Technologies
Washington Alloy Co
Watts Specialties Inc.
Wayne Trail - A Lincoln
Electric Co
Weifang Forward Welding
Materials Co Ltd
Weiler Corporation
Weld Engineering Co
Weld Pride USA For
Weldbrush
Weld Systems Integrators Inc
Weld-Aid Products
Weldas Co LLC
WeldComputer
Weldcode Metals
Welder Training & Testing
Institute
Welders Log
Welding Alloys USA
Weldobot Technologies Inc
Weldsale LLC
Welker Engineered Products
Wendt USA LLC
Wenzhou Xidin Electronics
Technology Co Ltd
West Chester Protective Gear
Western Enterprises
Wire Wizard Welding
Products
WireCrafters
Wisconsin Wire Works Inc
WITT Gas Controls
Wolf Robotics LLC - A
Lincoln Electric Co
Worldwel Co. Ltd
Wuhan Temo Welding
Consumables Co Ltd
Wuhan Welhel Photoelectric
Co Ltd
Wuxi Datang Welding &
Cutting Mechanical
Equipment Co Ltd
Wuxi Kenke Heavy Industry
Equipment Co Ltd
Wuxi Welcut Technology
Co Ltd
Wuxi Yincheng Science &
Technology Co Ltd
Wuzhou Ally Protect Co Ltd
Xiamen Honglu Tungsten
Molybdenum Industry
Co Ltd

WELDING

Xiris Automation Inc
Yaskawa America Inc
Yongkang Honcho Precision
Machinery Parts Co Ltd
York Portable Machine Tools
Zhejiang Changzheng Project
Carbon Electrodes Co Ltd
Zhejiang Jingwei Welding &
Cutting Technology Co Ltd
Zhejiang Poney Electric
Co Ltd
ZJ Industries Inc
ZRID Pty Ltd

EXPLORE NEW PRODUCTS AT FABTECH

The following pages in this New Product Preview offer a glimpse of what's in store at FABTECH. Find descriptions and images of new machinery, new materials and new processes listed by technology and company name. To view a complete list of all new products offered, click on the Exhibitor Search tab at fabtechexpo.com.

Additive Manufacturing/ 3D Printing/Rapid Prototyping

TRUMPF Inc

Booth B6309

TruPrint 3000

The TruPrint 3000 is a powerful additive manufacturing machine geared towards the production of complex metal parts. The TruPrint 3000 utilizes laser metal fusion technology and processes parts measuring up to 300 mms in diameter and 400 mms in height.

handle with a 360 degree rotating strain relief and detachable Steady-Grip™. UltraTIG torches also include industry renowned Super-Flex™ cables protected by a leather hose cover. Complete with an accessory kit including standard Gas Saver™ kit and consumables.

Assembly

Neff Press Inc

Booth A1432

E-Series Electric Servo Press



The E-Series Electric Servo Press uses integrated motion control and monitoring to achieve pinpoint accuracy and consistent high part quality. The compact machine offers a durable, energy efficient solution to precision assembly applications.

PAO CNC Hydraulic Dishing Presses



CNC PAO dishing line fast edition playback system.

Carell Corporation

Booth B8251

VBH 4 Roll CNC Parmigiani Plate Roll



Four (4) roll advanced technology plate roll with Stradivari 3D-CAD graphics. CNC controls including Facile and Field Bus digital and optical communication.

T40 DIGI Dual Axis Horizontal Press

The T40 Dual Axis Horizontal Press with digital programming and a powered back gauge will bend, fold, crimp, punch and form a variety of materials in flat, square, round, tubular and special shapes.

ETM-90HD Digital Heavy Duty 3" Pipe Bender

ETM-90HD Rotary Pipe and Tube Non-Mandrel Bender constructed from solid steel plate, no castings, 3" pipe and 3.5" tube capacity. Digital Touch Screen HMI with 40 programs x 5 bends each includes auto capacity material calculator.

Mono-2R High Speed 2 Roll Ring Former

Mono-2R High Speed Precision Roller is digitally programmable and uses a fixed interchangeable mandrel running against a Urethane lower roll to produce precision tubes and rings with zero unbent flats. Auto-load and eject systems are optional.

Cincinnati Inc

Booth B5543

60AF+4



The redesigned 60 ton Auto-form+ offers a fresh look with an available 6-axis backgauge, larger 22" HMI, and standard 11" stroke.

Faccin USA Inc

Booth B8209

4 Rolls Plate Roll 4HEL



Four (4) roll pyramidal electronic bending roll.

Angle Roll RCMI



The double pinch angle rolls of the RCMI series are precise and reliable profile bending machines.

Arc Welding

Abicor Binzel

Booth C12328

ABIMIG AT Manual Torch



The ABIMIG AT Manual Torch combines comfort and precision with a customizable solution and an amperage range from 250 to 400.

CK Worldwide

Booth C12074

UltraTIG Series Torches



These innovative torch packages feature a MasterTIG torch on a newly designed ergonomic

Bending/Forming

BOLDRINI

Booth B8209

RIBO 15ELCSF 4000 CNC Flanging Machine



Automatic CNC playback control flanging machine based on motion controls. Flange the first head, then move aside and watch the machine automatically flange the next heads without manual intervention.

Bending/Forming

3 Roll Variable Geometry Bending Roll HAV



HAV combines rolling power and maximum pre-bending precision.

Han Jie Machinery Co Ltd

Booth C10213

CNC Tube Bender (Model: HC-250LR-NSM)



This bender motion is driven by all electric servo motor (8 axis) to assure high accuracy and avoid high oil temperature issues. Dual direction bending arm is capable to do left and right side bending in one cycle.

MetalForming Inc

Booth B7511

Jorns TwinMatic



The Jorns TwinMatic is a totally automated bender which offers a revolutionary combination of engineering and computer automation.

ROUND0

Booth B8209

wCNC4 System

The ROUND0 wCNC4 System features updated graphic, improved functions and ease of operation.

Schwarze-Robitec GmbH

Booth C10623

CNC 220 E TB MR

Schwarze-Robitec GmbH introduces its fully electric multiple-radius tube and pipe bending machine featuring unique transport boost technology. Complex tube geometries with diameters of up to eight inches can be produced swiftly, flexibly and efficiently.

Steelmax Tools

Booth C13228

SBM500 Stationary Beveling Machine



A robust solution for beveling and deburring steel plate, angle, square/rectangular tubing and pipe. The SBM500 produces accurately milled weld preparations making part fit-up and root gap dimensions extremely precise.

Unison LTD

Booth C10452

All-Electric End Facing Machine for Tube & Pipe



Unison LTD introduces its innovative all-electric end facing machine for tube and pipe, aptly referred to as the Swiss Army Knife of end facing tools because it has multiple capabilities.

Coil Processing

Allor Manufacturing Inc/ Plesh Industries

Booth B9728

Patented Equal Plastification Leveler



The Equal Plastification Leveler provides flat strip with low HP requirements for CTL and coil to coil lines specifically for AHSS high strength steels.

MetalForming Inc

Booth B7511

Krasser Centurio



MetalForming Inc. introduces its fully automated coil processing system.

The Bradbury Group

Booth B7829

Bradbury eDrive® Leveling System

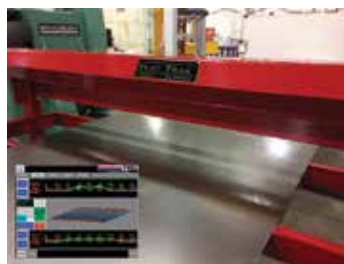

The Bradbury eDrive® leveling system provides up-to-date leveling technology.

Cutting

Allied Machine & Engineering

Booth A2921

GEN3SYS® XT Pro Structural Steel Insert



The GEN3SYS® XT Pro Structural Steel Insert offers a solution for beam and plate holmaking in the structural steel industry.

Hymson Laser Intelligent Equipment (Jiangsu) Co., Ltd.

Booth B9175

HF-G Series Fiber Laser Cutting Machine



The HF-G Series Fiber Laser Cutting Machine is an ultra-efficient all-round machine tool designed to handle massive metal cutting and long-term operating with many intelligent parts in both hardware and software.

Lockformer, Mestek Machinery Inc

Booth B5841

Vulcan Laser-Max Cutting System

The VulcanLaser-Max Cutting System laser cutting allows minimal heat affected on the piece edge and less ware to downstream equipment. Minimal kerf with 4-axis controls allows for intricate patterns.

Park Industries

Booth B9443

KANO™ HD Series

The KANO™ HD Series is built with accuracy on a truly unitized, precision machined, heavy-duty steel machine base. A range of cutting table styles and sizes are available including 6', 8', and 10' widths and 12' or 24' lengths.

Finishing**ACT Test Panels LLC**

Booth B4911

Audit Kits for Paint Lines

ACT Test Panels LLC audit kits for paint lines are designed with bare metal and treated metal panels to monitor quality and help identify and solve problems on paint and pretreatment lines.

Atotech USA LLC

Booth B4535

Master Remover 7000

The Master Remover 700 is a highly efficient, versatile and sustainable paint removal process developed to remove powder paints from hooks and racks of various substrates in spray or immersion as well as off-line or in-line applications.

Blast Services Inc

Booth B4529

Blast Guru Mobile Application

The Blast Guru app allows industry professionals access to individual machine data, process controls, maintenance tracking, operational inspections, mechanical inspections, abrasive consumption specifics, wheel comparisons and operational cost analysis.

Bossi srl

Booth B5841

Offline Surface Finishing for Round Products

Bossi F1 series of machines provide surface finishing or centerless grinding on round hollow or bar products made from ferrous and non-ferrous materials.



I need reusable masking wraps for my steel pipes that can withstand up to 500 degrees, and that I can install and remove easily.

Caplugs specializes in the design and production of custom masking solutions. With six different molding processes and comprehensive custom die-cutting capabilities, Caplugs can produce a masking solution for your most challenging applications.

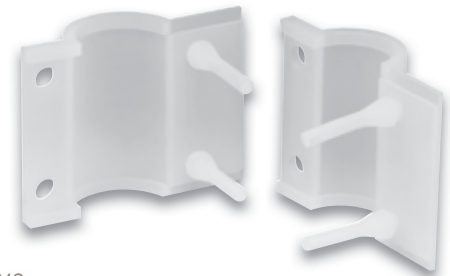

Custom solutions don't have to be expensive. With 3,000+ production-ready custom molds, an in-house tool room and an experienced team of masking specialists, a custom solution from Caplugs is fast and economical.

www.caplugs.com/masking • 1.888.CAPLUGS

 **caplugs**® | **Shercon**®
masking products

Visit us at FABTECH,
Booth #B5433

Finishing

Bradford Derustit Corp

Booth C12400
Wonder Gel



No mixing or measuring - apply industrial strength stainless steel pickling Wonder Gel directly to surfaces to remove stubborn impurities.

Caplugs

Booth B5433
CSP & CSPP Series Plugs



CSP and CSPP are designed to mask countersunk holes, mask the angled face of the countersink and can be used in high temp finishing processes such as powder coating.

Cibo NV

Booth C11368
Combi Unitized



Combi Unitized offers quick, easy, and risk-free removal of a weld seam in an inside corner and finishing to perfection.

Col-Met Engineered Finishing Solutions

Booth B5108
CT Air Make-Up Unit Product Line



CT AMUs are fully customizable over a wide range of air volumes up to 120,000 CFM, and offer the addition of humidity and temperature control as well as up to 10 orientations and PLC and Auto-Balancing as a standard configuration.

Dürr Systems, Inc.

Booth B5256
EcoGun AS MAN 1AF



The EcoGun AS MAN 1AF air spray gun features a pressure support gravity cup.

Fein Power Tools Inc

Booth C13438
Cordless Angle/Die Grinders



Ergonomic FEIN cordless angle/die grinders are designed for efficient cutting, grinding, and deburring work. Both have a dust-resistant and brushless FEIN PowerDrive motor.

GAT Finishing Systems

Booth B4921
Zero Emission Vent Fan



The Zero Emission Vent Fan requires no building penetrations. Capture and reuse most chemicals, with no environmental exposure to your building.

Gema USA Inc

Booth B5029
OptiStar® 4.0 and E-App



Monitor coating costs, collect productivity statistics, display diagnostic data and easily access equipment manuals with the OptiStar® 4.0 and E-App.

Henkel Corp

Booth B5036
BONDERITE® E-CO DMC Data Management System



The BONDERITE® E-CO DMC Data Management System is a process control system which enables users to run a complex chemical process cascade with multiple stages in metal pretreatment lines. Includes an intuitive touch screen PLC interface and supports laptop, tablet or smartphone interfaces.

Midwest Automation

Booth B6500
Mighty 9

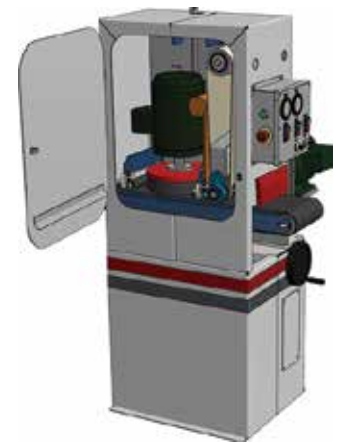

Mighty 9 deburring, finishing, and edge rounding machine. A compact, 9-inch wide dry machine designed with a belt head and top brush assembly for more versatility. Made in USA.

COPPER TITANIUM
NON-SPARKING NON-MAGNETIC
HAND TOOLS

Version 1.11

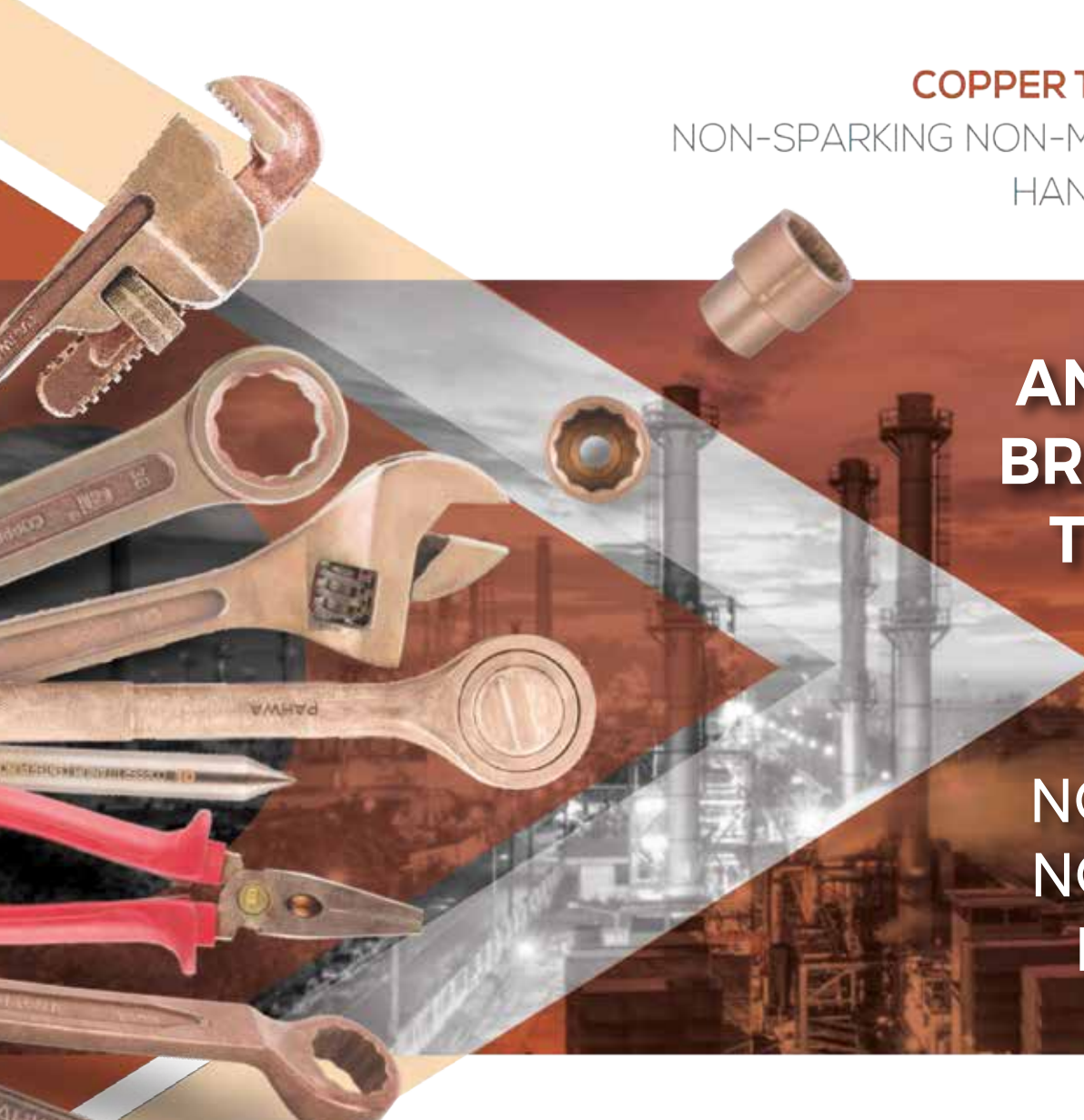

ANNOUNCING A BREAKTHROUGH TECHNOLOGY

NON-SPARKING, NON-MAGNETIC HAND TOOLS

| HAND TOOLS | STRENGTH | HEALTH HAZARD | DURABILITY | NON-MAGNETIC | MADE IN INDIA |
|------------------------|----------|-------------------|------------|--------------|---------------|
| QTi® (Copper Titanium) | ✓ High | ✓ No Risk. SAFE | ✓ High | ✓ Yes | ✓ Yes |
| Copper Beryllium | High | High Risk. UNSAFE | High | Yes | No |
| Aluminium Bronze | Low | Low Risk | Very Low | No | No |

NEED A CUSTOMIZED NON-SPARKING TOOL?

Safety should never be compromised. Be it a customized Spanner/Wrench or a Knife/Blade. We can do it all. We have the ability to design and customize QTi® Non-Sparking Tools to fit your needs.

FOR EVEN ONE TOOL

visit us at
FABTECH
Booth # A2843



PahwaMetalTech.co.in



877-338-9403
1stSourceProducts.com

the exclusive stocking
distributor of QTi
non-sparking tools for
North America

Finishing

Norton | Saint-Gobain
Booth C11110
QUANTUM3™ RightCut Wheels



Norton QUANTUM3™ RightCut Wheels, add cut-off capability to the Norton QUANTUM3™ (NQ3) line.

Omnirobotic
Booth B4855
OmniPainter™



OmniPainter™ can see, plan and paint any part, just like humans. No teaching, no programming.

Applicable on existing high mix finishing lines.

Richards-Wilcox Conveyor
Booth B4710
Mono-cart™ for Power & Free



Mono-Cart Power and Free Conveyors for finishing systems can accumulate, load and unload, or halt product carriers for a robotic stop while the chain still moves.

Sames Kremlin
Booth B5244
SAMES InoBell® Powder Bell Applicator



A high transfer efficiency applicator, the SAMES InoBell® Powder Bell Applicator delivers higher first pass transfer efficiency, better uniformity, and high finish quality.

Selas Heat Technology
Booth B5010
PC Package Burner



Selas PC Package Burners are designed for air heating applications with capacities from 200,000 to 30,000,000 BTU/hr. PC burners provide high turndown, reliable ignition, and flexible air/gas control options to maintain oven temperatures within 3°F.

Trimac Industrial Systems
Booth B4744
Small Parts Powder Coating

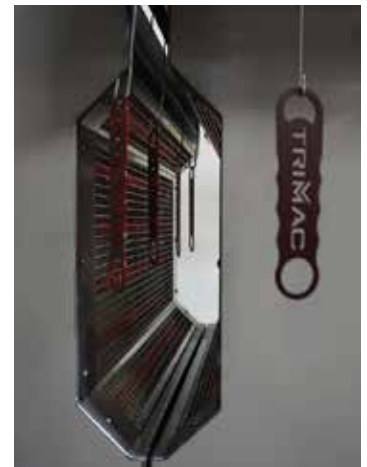

Designed to fit in a small footprint at a minimal investment, to wash, dry, coat and cure.



The Pit Bull™ is a Scrap Grapple with Real Teeth!

Bushman Equipment has a long history of product leadership in the design and manufacture of rugged, built-to-order material handling equipment. And now for slitting line users we are introducing the Pit Bull™—an air-powered scrap grapple designed specifically for cleaning out looping pits.



PIT BULL™

Visit us at Booth B5966

FEATURES

- Attaches to your overhead crane. No crane modifications needed
- Lifting capacity is 1000 pounds
- Powered by a standard 90 - 110 psi air supply line
- Operated by hand-held non-licensed radio remote control transmitter

FEATURES

- Heavy duty double acting air cylinders operate the high strength steel plate jaws
- Optional electric chain hoist that attaches to your crane hook and lowers grapple to the pit floor (if crane hook can't reach the pit floor)



BUSHMAN.COM
800-338-7810

Take a big bite out of your inconvenient and dangerous scrap metal cleanup.

Unleash a Pit Bull™ from Bushman!

Vapor Technologies

Booth B4839

VT-3000i

Helps customers more easily add coating capability to operations. Smaller footprint, easy to install, operate and maintain.

Gases & Gas Equipment**Abicor Binzel**

Booth C12328

EW2 / EWR 2 Net Gas Management System

EW2 saves on average 30 to 50% on shielding gas use. Track gas usage over a weld, a part, a production run, or any length of time desired.

Hydroforming**Chang Yee Steel Co Ltd**

Booth C10125

Hydroforming Tubes

High-strength steel tubes for hydroforming use.

Inspection & Testing**Ekide SL**

Booth A3144

EKIPANEL

A composite material sandwich panel for use in floor rail and bus industry applications.

Fischer Technology Inc

Booth B4854

FISCHERSCOPE® X-RAY XAN® 500

Coating thickness measurement and material analysis of alloys with FISCHER's lightweight, X-ray fluorescence (XRF) instrument. It can be used as a handheld device, a fully enclosed desktop unit or integrated directly into production lines.

PHASCOPE® PAINT

PHASCOPE® PAINT measures the thickness of paint layers on various substrates. Small and pen-shaped, it slips neatly into pockets, and it's designed to be simple to use.

Oasis Scientific Inc

Booth B9355

Vividia UM505 Autofocus USB/WiFi Dual Microscope

Can be connected to iPad/iPhone and Android devices and used on a laptop and PC through USB. Magnification up to 320x on 22" screen and 140x on iPad. Autofocus, HD videos, clear images, record videos and store picture.

Origin Technologies Corp

Booth C10164

TS800

The TS800 sensor with Blue Laser Technology is designed for inspecting small features such as scratches, corrosion, dents, radii, break/chamfer angles, gap/flush, step height and other measurements in hard-to-access areas on translucent or shiny surfaces.

Lasers**Alpha Laser - US**

Booth B5643

AL-Rock Laser

Mobile robot for targeted hardening of metal surfaces whether it be at a set work station or deployed on-site to a customer.

Amada America Inc

Booth B6909

9kW ENSIS 3015 w/ AMS 3015 CL

9kW ENSIS fiber laser technology utilizes an innovative resonator to automatically and precisely adjust the diameter of the laser beam enabling continuous processing of thin-to-thick materials.

Bystronic Inc

Booth B7229

ByStar Fiber 10kW with Automation

Designed for Fiber. High cutting dynamics, thin to thick cutting capabilities, seamless automation solutions, and intelligent sensor technology.

Dimeco Coil Technologies Inc

Booth B5938

LINACUT® - Coil Fed Fiber Laser and Turret Punch

Combines the flexibility of laser cutting and turret punching together with the performance of coil fed processes.

Guangzhou Cklaser Co Ltd

Booth A2617

TASTE

Advanced 3 Axis dynamic focusing system can achieve 3D curved surface marking. Auto-focus function, electric lifting, red light preview, Class 1 safety design.

Jinan Bodor CNC Machine Co Ltd

Booth B9435

Laser Cutting Machine, Laser Engraving Machine

Laser cutting machine applicable to various focal lengths, which are controlled by machine tool control system.

Lasers

Laser Mechanisms Inc

Booth C13560

FiberMINI® AF Laser Processing Head



Rated to 4kW and capable of cutting a wide range of materials with automatic, programmable focus. Features temperature sensing to protect optics, 15mm of automatic lens movement to set focus and optional capacitive height sensing.

LaserStar Technologies Corp

Booth B6600

Industrial Laser Welding Systems



State-of-the-art laser resonator technology which provides high peak power, optimal performance and throughput, higher up-time, enhanced electrical efficiency, and a space saving air cooled design.

FiberStar Fiber Laser Welding Workstations



Ideal for a wide range of metal joining, complex assembly, automation and repair applications for the industrial marketplace. Removable laser welding chambers are designed to be custom configured for the widest range of laser welding applications.

FiberCube Laser Engraving Systems



A compact, turnkey, marking, engraving and cutting system that offers the benefits of a non-contact, abrasion-resistant, permanent laser mark, engraving, or cut onto almost any type of material.

FiberStar Compact Laser Cutting System



FiberStar Systems come with 3-Axis (X/Y and optional Rotary) CNC system controller, an integrated computer with Windows operating system and ready-to-

use LaserStar MotionFX Software. This air cooled laser system is available in 150 and 300 Watt models.

Mold Repair Laser Welding Systems



Welding Systems ideal for a variety of common welding applications including plastic injection mold, dies and tooling repair, complex electronic components, high-precision industrial assemblies, pressure-sensitive hermetic laser sealing, and other unique industrial welding applications.

Lumentum

Booth B8967

2.1 kW Fiber Laser Engine, 1080 nm CORELIGHT YLE 2



CORELIGHT Series 2.1 kW fiber laser engines, based on highly advanced, compact 2.1 kW ytterbium fiber laser modules, offer straightforward integration into new and existing manufacturing tools and use a customer's existing power and control system.

4.2 kW Fiber Laser Engine, 1080 nm CORELIGHT YLE 4



CORELIGHT Series 4.2 kW fiber laser engine offer straightforward integration into new and existing manufacturing tools and use a customer's existing power and control.

Compact Picosecond Micromachining Laser PicoBlade®



The PicoBlade 2 laser system is a versatile tool for processing virtually any material with the highest precision and reliability. PicoBlade 2 incorporates Lumentum-proprietary, wear-and-tear free semiconductor saturable absorber mirror (SESAM®) technology.

Richardson Electronics Ltd

Booth B5840

Round Laser Bellow



Designed and manufactured in Europe, laser bellows are made with heat resistant, flame retardant materials and are able to withstand high operating temperatures.

Hycos Pumps



Replacement Hycos vacuum pumps for TRUMPF® CO2 laser systems.

SPI Lasers

Booth B5559
redENERGY G4 200W EP-Z



The 200W combines high pulse energy and a higher average power for rapid processing of multiple applications.

TRUMPF Inc

Booth B6309
TruLaser Cell 5030

The TruLaser Cell 5030 is equipped with a TruDisk laser offering an energy-efficient solution for 3D laser processing. The machine's flying optics and X-Blast feature ensure the cutting process is consistently accurate, reliable and robust.

Maintenance & Repair**Fein Power Tools Inc**

Booth C13438
Cordless Rotary Hammer Drill - ABH 18



Developed for professionals drilling into concrete or masonry. The drill is designed to achieve the same performance as a corded machine, where there is no power or limited power.

Richardson Electronics Ltd

Booth B5840
Laser Filters



High quality dust collection laser filters precision manufactured to match the exact specifications of any system.

Service Lamp Corp

Booth A2891
Philips TrueForce LED Lamp

TrueForce LED High Lumen Lamp for high bay lighting. Only 150 watts, as bright as a 400 watt lamp - 50,000 hours.

Stop-Painting.com

Booth A2854
5S and Lean Floor Markings and Signs



Superior Mark® Floor Tape is available in multiple colors and sizes to meet Lean and 5S marking needs as well as floor tape rolls, directional signs, corner markers, labels and signs to help contribute to the success of Lean and 5S plans.



No compromises.

Transforming machine tools with the first all-fiber, programmable beam quality laser that delivers maximum performance across all metals, all thicknesses.

n LIGHT

Visit us at Booth B8777

Material Handling/ Marking

InfoSight Corp

Booth B9629

KettleTag®PLUS



Galvanizing tags with text and barcodes that survive the entire galvanizing process.

PaintTag™



Ideal for tracking work pieces through acid prep and painting operations. Remove the laminate after painting and the tag will follow the work piece back to the fabricator or on to the customer site.

ShotTag™



ShotTag is designed to withstand bead and steel shot blasting applications. It carries identifying text and bar codes through acid baths, blasting and even painting.

GrateTag™



A special version of the KettleTag®Plus tag specifically to identify metal grates through galvanizing and installation.

Labelase® 1000 Tag Printer



Fully automatic, laser-powered desktop printer for coated metal tags.

InfoDent® ID8400™ Stamping System



The InfoDent stamping system is the preferred solution for dot-matrix stamped identification of steel mill products.

Labelase® 3000 Tag Printer



Fits easily on desk tops, or inside control cabinets and pulpits. Allows for longer tags with bigger bar codes and more and larger text.

Labelase® 4000 Tag Printer



High speed desktop metal tag printer sets a new standard for productivity. Sharp, clear text, bar codes, logos, graphics, and user selectable fonts.

MetalForming Inc

Booth B7511

Boekelt Tower



Know where all parts are at all times. This smart storage and inventory management system provides complete management for work-in-process and can tie into ERP or MRP systems.

Metreel Inc

Booth B9301

MET-TRACK Rigid Rail Anchor System - Fold Away



Engineered specifically for horizontal fall arrest / fall restraint applications.

Mighty Hook Inc

Booth B5032

External Powered Rotators



External powered rotators that allow variable speed, reversibility, and significantly improve coating application quality and efficiency at an affordable cost.

Strong Hand Tools

Booth C12440

BuildPro® Tube & Pipe Notcher



A modular, customizable notching system for use in prepping stock for fixturing. This Notcher enables the setup and control of round or square tubes and pipes.

TAB Industries LLC

Booth B6032

TAB Wrapper Tornado Exhaust Blower



An add-on designed to blow away excess plastic film. The exhaust blower automatically prevents the buildup of scrap on and around the blade, eliminates the potential for downtime to clear the material, and ensures smooth, uninterrupted operation.

Therma-Tron-X Inc

Booth B5045

Automated Conveyor Carrier (ACC) System



A material handling solution that incorporates a wireless network to send instructions to the carriers throughout a paint line. ACC's are hung on an overhead I-Beam and use an adjustable friction drive wheel.

Metal Suppliers

Hitachi Metals America

Booth A1344

YXR 33

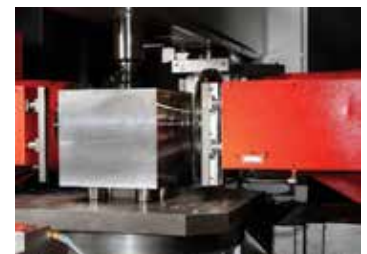

Matrix Steel that provides better toughness and wear characteristics than typical tool steel alloys.

**Other Machinery/
Equipment/Parts/
Products**

Alpha-Brush Aps

Booth A2786

GALAXY Rotary Deburring Machine



Rotary style deburring machine equipped with double rotation of the sanding heads.

Arro-Mark Co LLC

Booth B9732

Mighty Marker® High Purity Paint and Ink Pens



Marking pens which contain high-purity inks for safely marking nuclear pipes, vessels, stainless steel, and titanium.

Atlanta Drive Systems Inc

Booth B6835

Atlanta BV Hypoid Reducers



Standard range of Hypoid Reducers with features that include standard low backlash, high power density, smooth operation and mounting any servo motors.

Chase Cooling Systems

Booth B9865

Chase Chillers QBS AIR-Cooled Fluid Chiller



Available in 115/1/60 and 230/1/60 versions, these units are rated up to 1/2 ton or greater capacity, depending on operating conditions.

Darex LLC

Booth B6537

Darex Sharpener Stand and Vacuum Combination

The all aluminum Machine Stand is light, compact and designed to hold any of the Darex Sharpeners as well as additional wheels, chucks and accessories to help create a more efficient workspace. The Vacuum is compatible with all of the Darex Sharpeners

and is designed to help maintain a clean work area.

Dengensha America Corp

Booth C11452

Compact Feeder

Magnetic rotary feeder that is quiet, small, and maintenance friendly.

"LOOKING FORWARD TO SEEING YOU IN ATLANTA"



Lisa Johnson
COLE-TUVE, Inc.
Co-Owner



AFFORDABLE PRODUCTIVITY

We offer a complete line of Metal Fabricating Machines. Our professional sales team can help you find the right machine at the right price.

FABTECH
BOOTH
B7841

LARGE, IN-STOCK INVENTORY

(877) 989-0700
F (410) 933-0600
sales@coletuve.com
coletuve.com



COLE-TUVE, INC

SHEET & PLATE BENDING ROLLS • ANGLE & SHAPE BENDING ROLLS
FLANGING MACHINES • PRESS BRAKES • PRESSES • TRIM/BEAD MACHINES

Exclusive North American Distributor for 25 Years





With Walter on the job, nothing else cuts it.

Zip Wheel™

THE INDUSTRY'S LEADING AND MOST TRUSTED CUT-OFF WHEEL

Some might be satisfied with good. And some might settle for better. But when the only option is the best, it's got to be the Zip Wheel™ from Walter Surface Technologies. The Zip Wheel™ is engineered to deliver the most cuts in the industry. And only Zip Wheel™ features a patented rib design that cools the surface and reduces friction. That means no cut-off wheel cuts straighter, sharper, smoother, faster — or safer.

For more information, visit walter.com/zipwheel 1-800-522-0321

 **WALTER**
Surface Technologies
Only the best.™



 **FABTECH**

Visit us at booth C12160

**Other Machinery/
Equipment/Parts/
Products**

EH Wachs/Orbitalum
Booth C12512
PrecisePrep Heavy Wall Slide



A DynaPrep MDSF split frame accessory to counterbore and single point heavy wall preps. Ideal where internal obstructions exist, it utilizes an innovative configurable template and follower system.

Fein Power Tools Inc
Booth C13438
Magnetic Base Drill - JMU 404 M



Universal JMU 404 M magnetic base drill. The 4-speed machine has forward/reverse, Weldon 1-1/4", Weldon 32 and arbor adaptor, for smaller size cutter, the machine can drill diameters up to 4-11/32" with cutting depths of up to 4".

Galv-Pro Products
Booth B4932
Galv-Pen Plus, GPP-300



Galv-Pro pens contain the same time proven cold galvanizing material as its Galv-Match-Plus™. Meets the ASTM-A780 for superior corrosion protection.

The TVK-S range is the smallest in the family of compact vertical TVK machines. The processing area, control components, power systems and cooling systems are combined into one single system, which minimizes the surface area required on the ground.

MultiCam Inc
Booth B6229
Heavy-Duty Arcos Bridge & Rail Plasma



Combining the power of both Oxy Fuel and Plasma cutting, MultiCam's ARCOS is designed for heavy plate fabrication while still maintaining fast and accurate cut speeds and cut quality.

GH Induction Atmospheres LLC
Booth C10162
TVK-S Compact Induction Machines



ONE MACHINE DOES IT ALL

Precision Plasma Cutting & Drilling Machine
with **AUTOMATED UNLOADING SYSTEM**

FABTECH 2018 Atlanta, GA
Booth # B8467



Kinetic

www.KineticUSA.com | 1.800.606.2954

Multipress Inc

Booth A1537

Evolution Series Servo Presses

A 6-ton model from the Evolution Series of servo presses. The robust, traditional frame is outfitted with a servo electro-hydraulic actuator.

Paperboard Packaging Solutions

Booth B9515

Flexform Crate

Flexform is a custom made densely laminated paperboard crate from virgin liner board. Ships and stores flat and folds up rigid into various lengths, widths and caliper thicknesses. Offers beam strength and puncture resistance.

Replacement Brush Tables

Booth A2618

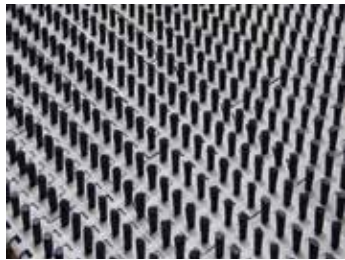
Brush Conveyor Belts

Modular brush conveyor belts can transport a wide variety of materials safely while preventing scratching and denting.

Scheugenflug Inc

Booth B4620

A220 Basic with Handheld Applicator

An optimized manual syringe, eliminating tedious labor, downtime, and costs of replacing syringes.

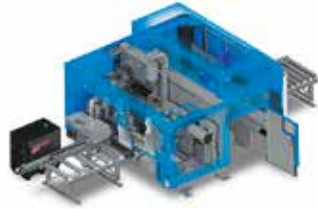
Plate & Structural Fabricating**Daito Seiki Co Ltd**Booth B9473
DCM1050

The Drilling Coping machine DCM1050 is a multi-tasking machine combining a CNC Drill (with 3 spindles), a CNC Robotic Coper for standard or complicated plasma cuts, and a marking machine for part number marking and welding / layout marking.

Ficpe Corporation

Booth B8117

Plasma Cutting Robot Model RAZ 1201

Laser technology scans all surfaces in seconds to provide dependable and accurate plasma cutting and layout marking on all four sides.

FlashCut CNC

Booth C13474

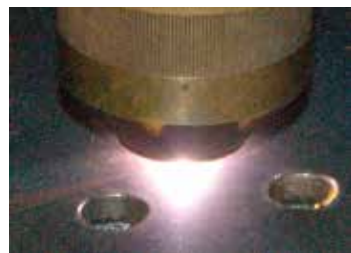
Smart360™ Hole Cutting Technology

Produces excellent quality holes and shapes using any plasma system including air and high definition.

Soitaab USA Inc

Booth B9057

Plasma NOVA

Plasma NOVA all function machine, cutting, bevel cut, drilling tapping, pipe cutting.

Voortman USA

Booth B8129

Voortman V310 - Plate Processing

A steel plate processor combining multiple processes in one machine. The V310 can be configured with a wide range of value-added features to meet the needs of various applications.

Voortman V808 - Robotic Thermal Cutting

Copes, bolt holes, slots, notches, marking - the Voortman V808 can cut it while reaching all 4 sides with exceptional cutting accuracy and speed. Both plasma and oxyfuel torches are available, plus cut-to-length capability.

Press Brakes**Amada America Inc**

Booth B6909

HG 1003 ARs

A fully-integrated robotic bending system with a 6-axis robot, Automatic Gripper Changer (AGC), and Automatic Tool Changer (ATC) with patented AMADA tooling.

HG 1003 ATC

The HG servo/hydraulic press brake and Automatic Tool Changer (ATC) provide the optimal bending solution for high-mix, low-volume production.

HM 1003

A hydraulic-powered press brake designed for efficient, accurate, and repeatable bending at an exceptional price-performance ratio.

EG 4010

An ideal compact press brake solution to produce small sheet metal components that demand a high degree of precision. A key feature of the EG is its high-speed Dual Servo Power (DSP) Drive System

Press Brakes

Automec Inc

Booth B6866
CNC 600 Control



The CNC 600 control is updated while maintaining a simplistic programming approach. It comes standard with USB job storage and a 15" color touch screen.

Bystronic Inc

Booth B7229
Xpert 150 Press Brake



Xpert 150 press brake equipped with the revolutionary Bystronic ByVision Bending control.

Mobile Bending Cell for Xpert 40 Press Brake



Mobile robot automation meets high-speed bending with the Xpert 40 Mobile Bending Cell, a compact solution for automated as well as manual operation.

MetalForming Inc

Booth B7511
CoastOne Press Brakes



High precision press brakes, all with signature servo-electric direct drive. The CoastOne G-series offers bending lengths up to 160 inches, driven by up to six ball screws.

Pacific Press Technologies

Booth B9457
Eco-Former C-Frame Press



A heavy-duty C-Frame press. Capabilities include stamping, forming, drawing, and punching. Standard features include a heavy-duty welded frame, commercially available hydraulics, and digital stroke control HMI.

Servo Press Brake



BLAISE family of servo hydraulic press brakes improve efficiency, with more time spent on value-added work.

Punching

DTC Products Inc

Booth A1239
SlugKeeper Slug Retention Machine



This patented machine allows to put SlugKeeper Grooves in all of die openings accurately to stop slug pulling.

Sankyo Automation

Booth A1411
RollerDrive Servo Rotary Tables



Designed to fulfill the demands of the latest machine tools for increased speed and precision. Inside, Sankyo rotary tables use a RollerDrive mechanism and zero-backlash reducer technology.

Resistance Welding

WeldComputer

Booth C11915
5,000 kVA AC Inverter Replaces SCR Control



A 5,000 kVA supply for high-power applications such as large grating welders. Made of modular elements, it meets power requirements.

Robotics

Abicor Binzel

Booth C12328
ABIROB Cyclone Robotic Torch

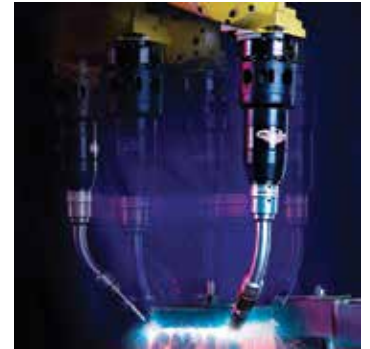

Robotic torches using endless rotation technology to allow the torch neck to rotate 360-degrees completely independent of the welding cable.

TH6x Optical Seam Tracker



The 3-line Optical Seam Tracker TH6x uses laser line technology to track the joint and guide the torch through the weld. For robotics and hard automation.

TES Torch Exchange System

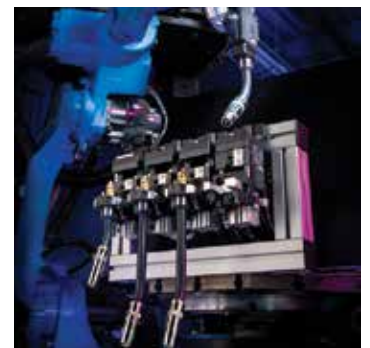

TES allows for quick and reliable exchanging of torch necks for preventative maintenance with controls via PLC or Field Bus.

Find Up! at FABTECH Booth #B9516

Introducing The Up! App



Trusted Options for
Machine Repair

Join the Service Revolution

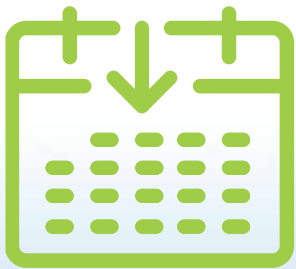

Send Service
Requests



Receive
Responses



Schedule Repair
Service

www.TheUpApp.com
Download now!

Robotics

AGT Robotics

Booth C13048
BeamMaster WELD



Robotic Welding Line specially engineered to answer all the welding needs of structural steel fabricators and a wide range of other industries.

Electron Beam Technologies Inc

Booth C13009
Dura Dome, Box Pax

EBT's clear dome is the standard for visual observation of welding electrode in all automation applications.

Fenn

Booth C10153
Fully Automated Turn-key Swaging Solution

Fenn introduces its Fully Automated Turn-key Swaging Solution with a suite of features designed to work collaboratively to increase production, reduce cost, and maximize operator safety.

Metalix CAD/CAM Ltd

Booth B9607
MRobot Programs & Simulates Robotic Bending Cells

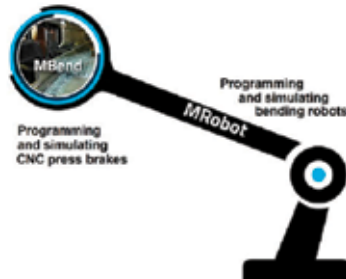

Offline programming and simulation of robots for bending cells, and an intuitive job tracking module with material management and job scheduling for orders.

Murrplastik Systems Inc

Booth C10847
Flexible Holding System for Cobots



Designed for use with or without additional parts. Two base bodies exist: first, the FHE, in which conduits and cables can be inserted directly and a UHE holder can be mounted alternatively.

NOXON Automation USA LLC

Booth A1120
SWB 4-08 + BVX 80



Fully automatic reel winder for blister tapes.

New, Improved BUILDPRO® ROTARY POSITIONER

The Rotary Positioner provides precise, gear driven, free-turning plane rotation of your BuildPro® or Siegmund® Welding Tabletop for better weld access.

NEW Gear Box features precision gear geometry for high load capacity, high efficiency and reliability.

NEW Adjustment Plates help shift the center of gravity for tall or heavy parts.



Strong Hand Tools

Toll Free: 800.989.5244
 StrongHandTools.com

FABTECH

Nov. 6 – 8, 2018
 Georgia World Congress Center,
 Atlanta, GA
 Booth# C-12440

Safety & Environmental

Denray Machine Inc

Booth C11021

The Dust Funnel



The Dust Funnel specifically targets CNC routers and other machines that create airborne dust during blow-off.

Diversitech

Booth C11374

Airhawk Cartridge Dust Collectors



Airhawk Cartridge Dust Collectors feature an innovative, modular design that effectively eliminates dust, smoke and other airborne contaminants from work environments. Heavy-duty for continuous operation industrial applications.

Saws & Cut-off Machines

Dake Corporation

Booth B8811

SE 5X6 RCT Benchtop Bandsaw



Semi-automatic benchtop horizontal bandsaw features reverse cutting technology for cooler cutting and faster, cleaner cuts.

SE 5X8 Benchtop Bandsaw



Benchtop horizontal bandsaw designed for on-the-go applications. This saw will cut metal rounds, flats, and tubes right in the field.

Jepson Power Inc

Booth A2500

LBS Schockresistant Sawblades Superthin



Ideal for cutting: metal grids and grates, trapezoidal sheets, metal profiles, conduits, shutter pipes and much more. With 1.0 up to 1.5 mm LBS-blades are much thinner than conventional saw blades.

Starrett Company

Booth B7737

Band Saw Blades & Hole Saw PowerCalc Pgm



Starrett Versatix™ MP bi-metal band saw blades feature triple-tempered, high-speed M-42 cobalt steel teeth with an alloy steel backing strip. PowerCalc program de-

termines the correct Starrett Hole Saw, operating speeds, and power tool or machine.

Software & Machine Controls

AMS Controls Inc

Booth B9450

Eclipse Pro

Eclipse Pro Production Management Solution software combines the ease and accessibility of the internet with the strength of real-time data to help manufacturers accomplish more in less time.

Bystronic Inc

Booth B7229

Manufacturing Execution System



The Manufacturing Execution System (MES) is a software solution that creates digital transparency across the entire process chain. MES allows users to plan, direct and evaluate work flows according to defined timelines.

ByCockpit



An app that analyzes and visualizes the process data associated with sheet metal production in real-time making the quality, times, and cost of production transparent and optimizable.

BySoft 7 Software Package

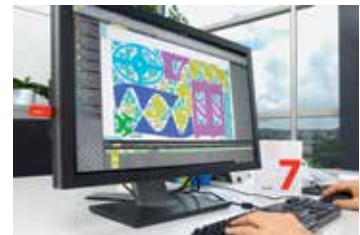

BySoft 7 software supports both 2D and 3D CAD and provides an extensive array of process, scheduling and monitoring functions.

Epicor Software Corp

Booth A2942

ERP 10.2

Epicor provides a new level of user experience, collaboration, visibility and connectivity to help achieve growth objectives.

FabSuite LLC

Booth B9659

FabSuite Services

FabSuite is known for high-quality customer service, a deep integration with all the other software steel fabricators use, and a reputation for improving efficiency and productivity.

Fenetech

Booth A3055

Q2S Guided Visual Manufacturing



Onboard skilled workers smoothly and reduce production errors with on-screen shop floor visual instructions at each manufacturing step plus labor, downtime and quality data. Available stand-alone, with Q2S ERP or integrated into a current system.

Software & Machine Controls

Richardson Electronics Ltd

Booth B5840

REdiUnit 4.0



A systems monitoring device containing a mobile SIM card, antenna, power supply and cables and connects to an output port of the generator controller of certain laser machines as specified in the REdi 4.0 user manual.

Scientific Forming Technologies Corp

Booth A2161

DEFORM V11.2

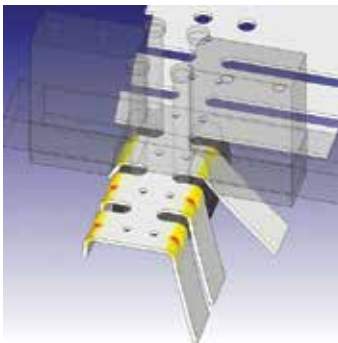

Process simulation software for bulk metal forming. It is ideally suited for forged, rolled and sheet metal parts where thickness variation, fine feature detail, thermal effects and through-thickness behavior are critical.

Toledo Integrated Systems

Booth A1545

ZT-SLIM Tonnage Monitor



The ZT-SLIM is a resolver based tonnage signature interface module that provides force measurement and signature analysis for critical force applications up to 800 spm. Designed and configurable for single action, double action and servo presses.

Trimble Solutions USA Inc.

Booth B8922

Tekla Structures 2018

Improved productivity and workflows for steel detailing and drawing production. Speed up modeling, enhance collaboration and enable better drawing creation.

TST Tooling Software Technology LLC

Booth A1124

TSTracker Job Tracking Software

Tool shop tracking software for the Tooling and Production industries.

TWI North America LLC

Booth C12066

Welding Qualifier

Software for welding procedure (PQR/WPS/pWPS) and welder (WPQ) qualification. Built-in code rules for ASME, AWS and ISO codes.

Stamping

Dees Hydraulic Industrial Co Ltd

Booth B9421

HD-2500 Tandem Line



2500 tons of tandem lines for the automotive manufacturing industry.

Greenerd Press & Machine Company Inc

Booth A1245

Transfer Line



The Greenerd Transfer Line has three stations which draw, re-draw and punch the component. The draw presses are 250-ton capacity and the punch press, a 150-ton capacity machine.

Oneda Corporation

Booth A1156

Multi-Tooling



Tool technology and robotic transfer manufacturing capabilities allowing multiple parts to be stamped at the same time, significantly reducing tool expense, improving cost and increasing capacity.

Tool & Die

Agathon Machine Tools Inc

Booth A1439

Mini Fine Centering

High precision guide components configured to save the tool builder valuable space, time, and cost.

Fibro Inc

Booth A1569

Wireless Pressure Monitoring



Constantly monitors the pressure and temperature in gas springs. Sensors wirelessly transmit data to any Windows-based system. Custom software analyses the data and initializes the necessary process control steps.

Linco Precision Industrial Co. Ltd.

Booth A1258

Customized Forming Mold and Die Plate



Custom shaped mold plate ranging max 350*350 to the core of the molds for key forming.

Meusburger US Inc

Booth A1440

Limit Switches with Roller or Dome Plunger



Robust housing with ingress protection IP67, different installation positions due to adjustable roller, universally usable through various electric connection options.

Shenzhen Powstar Technology Ltd

Booth A1316

Casting Iron and Steel Dies



Automotive parts, Category B (BIW non structural components, BIW structural components, Seating components and Bumper components), Category C and Category D.

LOCKFORMER

since
1938

THE NEW SOLUTION FOR SHEET METAL LASER CUTTING



**COIL FED LASER CUTTING,
2X MORE PRODUCTIVITY!**

VULCAN® LASER MAX 1.5 CUTTING SYSTEM



With 30 years sheet metal cutting experience, the **Laser-Max 1.5** is the next evolution in Vulcan Cutting Systems:

- Ideal for cutting light gauge sheet metal
- Unique fiber laser guarding enables full table access, to support a high mix, job shop production
- Increased cutting speed, broader range of materials and superior cut edge compared to plasma cutting
- Feed the laser Cutting Table from Coil for 2x more up time compared to Sheet Fed Lasers
- Fiber Laser offers lower maintenance and operating costs compared to Plasma or CO2 Lasers

SEE US AT BOOTH B5841

FABTECH

November 6-8, 2018 • Atlanta, GA



319.364.9181

5480 - Sixth Street S.W. • Cedar Rapids, IA 52404 • Email: sales@mestekmachinery.com • Website: mestekmachinery.com



/MestekMach



/MestekMachinery



/MestekMachinery



/MestekMachinery



FREE CATALOG
REQUEST!



The FIRST Premier Partner Program Member
of the AIAA Elite Group



COMPANY
WEBSITE



DIGITAL
CATALOG

Tooling

Chicago Pneumatic Tool Co

Booth A3051

CP3550 Series Angle Grinder/Sanders



CP3550 series of grinders and sanders feature top of the line performance, industry leading safety, and unparalleled user comfort.

Hangzhou Wagen Precision Tooling Co Ltd

Booth C10145

Circular Saw Blade



Circular saw blade for solid wood, particle board, MDF and Aluminum cutting, and COLD saw blade for metal cutting (solid bar, tube and Stainless steel).

Tube & Pipe Fabricating or Welding

AMOB SA

Booth C10852

eMob 63



eMob 63 all electric 9-axis multistack CNC bending machine with a large variety of included options.

Dynobend BV

Booth C10852

Dynobend CB76 MR



Fully servo-controlled Dynobend CB76 MR all-electric rotary-draw and 3D freeform bending machine for bending (cold forming) and rolling of tubes and profiles.

Herber Engineering AB

Booth C10852

350RL



High torque 1.50" capacity CNC tube bending machine. Available in 1", 1.5" and 2.25" capacity.

ITEC - Innovative Tube Equipment Corporation

Booth C10852

MTS - TPU 38



When combined in work cells these machines can utilize the combination of standard machinery for an almost endless variety of applications such as cutting, single or twinhead bending, punching, forming, flattening, coping, milling and drilling.

KLINGSPOR Abrasives Inc

Booth C13025

KLINGSPOR A 630 N



FastCut 14" cut-off wheel produced for low power portable chop saws. At 3/32" thick, the A630N wheel has reduced side friction for fast, smooth cuts and less burr. For use on all steels, profiles, tubes and solid material.

Star Technology S.r.l

Booth C10852

800CN3



Starbend 3-axis electric CNC bending machine with a variety of features.

Strong Hand Tools

Booth C12440

Magnetic Grasshopper



The Magnetic Grasshopper Clamp locates and holds steel stock in the vertical position for tack welding. The spring-loaded Grasshopper clamp arm delivers positive, self-adjusting holding pressure.

MagHold™ V-Pad Kits



Use for light duty and tight spot holding. Build, hold, and position steel for tack welding. Hold flat, round, and square parts in light duty substructure applications.

MagTab™ Jumbo



A larger version of the MagTab™ product. MagTab™ hold tabs in place for tack welding. Hold tabs, or any small metal pieces, parallel or perpendicular to the substructure.

Rotary Positioner



Horizontally mount the BuildPro® or Siegmund® Welding Tabletop to the Rotary Positioner for plane rotation of a welding tabletop.

BuildPro® Reversible Table Plates

Modular BuildPro® Welding Table plates are now reversible. The plates can now be turned over to provide a new work surface.

TRUMPF Inc

Booth B6309
TruLaser Tube 7000 fiber

The TruLaser Tube 7000 fiber combines the high speeds of a solid-state laser with a broad range of processing capabilities. It can cut tubes and profiles with diameters of up to 254 millimeters and materials as thick as 10 millimeters.

Waterjet**OMAX Corp**

Booth B6951
GlobalMAX 10hp Pump



10HP pump for the GlobalMAX JetMachining Centers that provides 30,000 psi rendering a 0.4 gpm flow rate. The direct-drive pump with variable frequency drive (VFD) technology requires 480V / 25A power supply.

Water Jet Sweden AB

Booth B9844
FiveX Waterjet System



Built with high end technology for advanced free form cutting. Used in high tech industry sectors, built to repeatedly perform high precision free form abrasive waterjet cutting of complex 3D components.

Welding Consumables**Anand Arc Ltd**

Booth C13525
CO2 MIG WIRE



Welding wire with the latest technology and production capacity of 1000 tons per month with expansion going on to reach 2000 tons per month.

Trafimet Group S.p.a.

Booth C13069
T-SYSTEM®



T-SYSTEM torches are developed with a unique configuration concept to fully satisfy every need.

Weiler Corporation

Booth C11318
Tiger Specialty Cutting, Grinding, & Combo Wheel



Tiger Ceramic, Aluminum, and UltraCut wheels handle serious stock removal on hard to grind metals, work with aluminum and perform precise cuts on thin metal.

Roughneck Max Stringer Bead Wheel

These 4-inch carbon steel and stainless steel brushes deliver 40 percent more cleaning power and require less pressure to clean with.

Tiger & Wolverine Resin Fiber Discs

Tiger Ceramic, Zirc and Aluminum, and Wolverine Zirc and Aluminum Oxide discs are designed to provide an aggressive cut rate and smooth finish.

Zhejiang Jingwei Welding & Cutting Technology Co Ltd

Booth C13209
JW PYREX Series of TIG Torches



Used in precise welding to guarantee welding quality while TIG welding.

Welding Machines/ Equipment**Abicor Binzel**

Booth C12328
Fume Extraction System FEC



A single torch fume extraction system, using cyclone technology for particle pre-separation to protect the filter surface and reduce cleanings.

American Weldquip LLC

Booth C11322
Water-Cooled Torch Flow Switch



Water Cooled Semi-Automatic Torch with Integrated Flow Switch.

Welding Machines/ Equipment

Dengensha America Corp

Booth C11452

LinearWave 75kA



The 75kA version has been added to Dengensha's welding technology that combines MFDC and capacitor discharge welding.

Heck Industries

Booth B9101

Weld Shaver



The Weld Shaver uses carbide inserts in a milling cutter and quickly and cleanly removes weld bead flush accurately.

Kayo Products Co Ltd

Booth C13537

KV-315FC



Torch handle with built-in flashback arrestor and check valve.

Miller Electric Mfg Co

Booth C12628

Trailblazer® 325 Diesel Welder/ Generator



The Trailblazer® 325 Diesel welder/generator maximizes runtimes and fuel efficiency and reduce expenses with the combination of Auto-Speed™ technology and Excel™ power. Now with five Auto-Speed rpm levels, weld up to 135 amps while the engine remains at idle (1,800 rpm).

XMT® 350 FieldPro™ with Polarity Reversing



Quick-Select™ technology automatically selects the welding process, correct polarity, cable outputs and welding parameters. Reduces training time and increases quality. Optimized stick and TIG performance is designed for open root pipe welding.

Insight Centerpoint™ 10

This updated version of Centerpoint software is designed for greater ease of use, faster startup time and a drastically shortened learning curve — so manufacturers can detect missed welds, verify proper weld sequences and ensure consistent weld quality.

ArcAgent™ for Insight Core™

Get the benefits of weld data monitoring across an entire welding fleet, regardless of manufacturer, for a full understanding of productivity, arc-on time and weld parameters in the welding operation.

Morris Precision Technology Company Limited

Booth A3255

SM-503 Little Welding Torch



Torch with a rugged aluminum alloy body, including 5 welding tips made of brass. Diameter 0.6mm by waging machine. Used with two-color 200cm hose and 9/16"x18N inlet connection.

Orbitalum

Booth C12512

OM180 SmartWelder Orbital Welding System



Orbital welding system, built to ISO standards with IIoT connectivity capabilities. The SmartWelder offers a fully customizable data capture system.

Phoenix International Inc

Booth C13021

EcoPRO



A 10 pound, portable oven that will effectively keep electrodes moisture-free. Ideal for both large jobs requiring a temporary oven and for independent welders.

Steel Vision Tools

Booth A3045

Badass Welding Table



Full line of welding tables, work benches and storage solutions. Extremely heavy duty and customization to meet all needs.

Weld Engineering Co

Booth C11628

Mighty-Mac-7500X Submerged Arc Vacuum



Mighty-Mac-7500X Super Duty, 7.5 HP Flux Recovery Vacuum and Dust Collector with 7.5 HP motor and 2 large dust filters. Auto clean filters and a large dust drawer to store flux dust.

MV-5 Small Heavy Duty Electric Flux Vac

Comes with FHMV5-100 Flux Hopper (100 LB. CAPACITY). Very quiet, no high pitched sound. 115 Vac plugs into most welders (8 AMPS). Dust falls into removable dust pan. Low Maintenance.

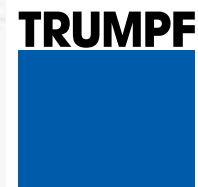

 **TruLaser Cell 5030**



For Productive and Affordable 3D Cutting

Put Your Confidence in TRUMPF The New TruLaser Cell 5030

Fabricators seeking a new dimension in laser cutting will want to experience the new TruLaser Cell 5030 at FABTECH. Equipped with a solid-state TruDisk laser, flying optics and state of the art NC controller and motion unit, the TruLaser Cell 5030 delivers a production increase of 200 percent compared to typical hybrid machines - while saving 50 percent in operating costs. Advanced processing technology developed for TRUMPF's high-performance 5-axis product line ensures outstanding cut quality, process reliability and flexibility. While the rest of the pack is in slow motion, take the lead with the machine that's built for quality, productivity and affordability. Put your confidence in TRUMPF – Together we can build your success.

See the new TruLaser Cell 5030 at FABTECH in booth B6309 / www.trumpf.com

SPECIAL EVENTS

There are a lot of great events happening this year at FABTECH. You won't want to miss the keynotes, expert panel discussions, Smart Manufacturing Hub and much more. All events are free and open to all attendees unless otherwise noted.

TUESDAY, NOVEMBER 6

KEYNOTE PRESENTATION

8:45 AM - 10:00 AM

FABx TECH TALKS

Embracing the wildly popular TED-style concept, the FABx Tech Talks will spotlight visionary leaders who will motivate and inspire attendees via short inspirational talks on the topics of transformation, growth, advancement and expansion for the future of manufacturing.

FEATURED SPEAKERS:

- Dennis Adamovich, *CEO, College Football Hall of Fame*
- Julia Crews, *Sr. Change Management Training Consultant, Ignite Women Leaders Founder*
- Charlie Covert, *VP of Customer Solutions, UPS*
- Shawn Cole, *Vice President - Delta Cargo, Delta Air Lines, Inc.*
- Dan Kara, *Vice President, Robotics, WTWH Media*
- Aaron Kaufman, *Shifting Gears (Discovery Channel), Owner, Arclight Fabrication*

EXPERT PANEL PRESENTATION

12:30 PM - 1:30 PM

INNOVATE, ACCELERATE AND ADVANCE MANUFACTURING

Learn how companies are using innovation and advanced technologies to stay at the forefront of manufacturing and how they embrace disruptive technologies to remain competitive and profitable.

6:30 PM - 8:30 PM

INDUSTRY NIGHT AT MERCEDES-BENZ STADIUM Featuring Legendary Football Coach, Steve Spurrier

Enjoy an evening of fun, food, drinks and networking during our Industry Night Party at the spectacular Mercedes-Benz Stadium. The evening will include exclusive access to the field, on-field activities, stadium tours, and a keynote and meet-and-greet with special guest and legendary football coach Steve Spurrier.

Advance Industry Night ticket price: \$75

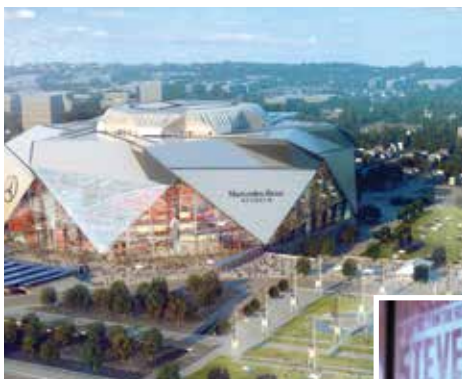

Sponsored by:



WEDNESDAY, NOVEMBER 7**8:00 AM - 10:00 AM****WOMEN OF FABTECH BREAKFAST**

Join us for a networking breakfast celebrating the importance of women in the manufacturing sector.

Price: \$25**KEYNOTE PRESENTATION****8:30 AM - 9:30 AM****KYLE PETTY****NASCAR Icon and Philanthropist**

What a Ride: Life, Family, Community and the Race Track

During this presentation, Petty takes audiences on an anecdotal journey through his

life as a businessman, philanthropist and as one of NASCAR's most respected drivers.

Sponsored by:  **Desktop Metal™**

EXPERT PANEL PRESENTATION**12:30 PM - 1:30 PM****STATE OF THE INDUSTRY**

Hear our experts share how important the future of the manufacturing industry is to the U.S. economy.

THURSDAY, NOVEMBER 8**6:30 AM - 8:30 AM****RUN4MFG 5K**

Join FABTECH at the 5th RUN4MFG 5K in Centennial Olympic Park and show your support for the future of manufacturing!

Advance Cost: \$35.00
(includes a RUN4MFG T-shirt)

KEYNOTE PRESENTATION**8:30 AM - 9:30 AM****JONAH & DAVID STILLMAN****Best Selling Authors and Generation Experts**

Make Way for Gen Z!

Generation expert David Stillman teams up with his Generation Z son Jonah for this fresh and innovation presentation that will shed light on what

makes this newest generation tick.

EXPERT PANEL PRESENTATION**10:30 AM - 11:30 AM****MANUFACTURING AND THE NEW GENERATION WORKFORCE**

This lively discussion will bring together a panel of experts who will share a new perspective and help your company understand how to adapt and attract this new generation of employees.

TUESDAY, NOVEMBER 6 - THURSDAY, NOVEMBER 8**KNOWLEDGE BAR: Ask the Experts**

The Knowledge Bar held on the show floor in the 3D/Additive Manufacturing Pavilion will hold small group sessions that are designed to provide the opportunity to ask questions about your specific 3D/additive manufacturing challenges and get "the scoop" from industry experts.

SMART MANUFACTURING HUB

The Smart Manufacturing Hub will feature several advanced manufacturing technologies, including automation, advanced materials, 3D printing, the Industrial Internet of Things (IIoT), 3D scanning, and more.

TUESDAY, NOVEMBER 6

SCHEDULE-AT-A-GLANCE

| TECHNOLOGY | 8:00 AM – 10:00 AM | 10:30 AM – 12:30 PM | 1:30 PM – 3:30 PM | |
|---------------------------|--|---|--|----------|
| 3D/ADDITIVE MANUFACTURING | NEW! F10: Revolutionizing 3D Additive Manufacturing I | NEW! F20: Introduction to Additive Manufacturing and 3D Printing B | F30: Fundamentals of 3D Additive Scanning and Imaging I | |
| AUTOMATION | NEW! F11: Robotics and Automated Systems for Joining and Laser Industry 4.0 I | F21: Getting Started with Robotics B | NEW! F31: Automation Software for Fabrication Business I | |
| CUTTING/LASER | NEW! F12: Lasers and Innovative Industrial Applications I | NEW! F22: Advanced Fiber Laser Applications & Developments I | F32: Comparative Cutting Systems with Tech Tour B | |
| FINISHING | | C20: Building Blocks of Powder Coating B | C30: The ABCs of Infrared B | |
| | | C21: Fundamentals of a Successful E-Coat Operation B | NEW! C31: First Things First - Hanging and Masking I | |
| | | C22: Pretreatment Challenges I | C32: New or Improve - What's Best for Your System I | |
| FORMING & FABRICATING | F13: Coil Processing: Advancements in Slitting, Leveling and Storage I | NEW! F23: Press Brake Springback Solutions I | F33: Press Brake Safety: ANSI B11.3 Explained I | |
| | F14: Roll Forming: In-Line Punching, Cutoff Dies and Press Tonnage I | F24: Welding Advancements for Tube & Pipe I | F34: Tube & Pipe: Bending I | |
| LEAN | NEW! F15: Lean Principle: Strategic Planning and Organizational Alignment I | NEW! F25: Lean Principle: Developing Your People I | F35: Lean Tools: Value Stream Mapping, Addressing Differences Between Office and Shop Floor I | |
| MANAGEMENT | F16: Fundamentals of Activity-Based Costing & Estimating I | NEW! F26: Rising Above It All: The Art and Science of Organizational Transformation I | NEW! F36: Becoming a Learning Leader and Avoiding the Fatal Flaws of Failure Part I and Part II I | |
| MARKETING & SALES TOOLS | | NEW! F27: Increase Your ROI with Digital Marketing for Manufacturers I | NEW! F37: Marketing Bootcamp: Technology, Prospects & Voice of the Customer B | |
| SMART MANUFACTURING | | NEW! F28: Roadmap to Smart Manufacturing Transformation I | NEW! F38: Smart Manufacturing Technology & Workforce Ready B | |
| STAMPING | | S20: Machine Safety - Safeguarding Overview I | NEW! S30: Machine Safety - Alternative Methods for Applying Hazardous Energy Control I | |
| | | S21: Lubrication Technology I | NEW! S31: Sensor Technology - Eliminating Die Crashes I | |
| WELDING FABRICATION | | NEW! W20: Welding for Steel and Aluminum Applications I | NEW! W30: Welding for Laser & Cutting Repair Technology I | |
| WORKFORCE DEVELOPMENT | NEW! F19: 8 Elements to Effective Delegation & How to Get More from the People You've Got B | NEW! F29: Innovative Techniques to Manage Significant Improvement and Change Initiatives I | NEW! F39: The Beauty of Being Lost: Make Better Decisions & Lead Change In Your Organization I | |
| WELDING | | | | |
| SEMINARS | W10: NDT Day | | 8:00 AM | 5:00 PM |
| | W13: CWI Part B Hands On Experience - Day 1 | | 8:00 AM | 5:00 PM |
| | W14: Welding of Stainless Steel - Day 1 | | 8:00 AM | 5:00 PM |
| CAREER PATH WORKSHOPS | W16: Starting a Welding Inspection Business | | 10:00 AM | 12:00 PM |
| | W17: Creating a WPS in 60 Seconds | | 1:00 PM | 3:00 PM |
| | W18: Welding Engineers Round Table Discussion | | 3:00 PM | 5:00 PM |
| PROFESSIONAL PROGRAM | W23: Session 1: Additive Manufacturing | | 8:00 AM | 12:00 PM |
| | Session 2: Modeling and Numerical Analysis I | | 8:00 AM | 12:00 PM |
| | Session 3: Welding Metallurgy | | 8:00 AM | 12:00 PM |
| | Session 4: Sensing and Control of Welding Processes | | 2:00 PM | 5:00 PM |
| | Session 5: Solid-State Processes | | 2:00 PM | 5:00 PM |
| | Session 6: Weldability Studies | | 2:00 PM | 5:00 PM |
| EDUCATIONAL SESSIONS | W28: National Center for Welding Education and Training, Weld-Ed | | 10:00 AM | 3:00 PM |
| RWMA SCHOOL | W22: RWMA Resistance Welding School - Day 1 | | 8:00 AM | 4:15 PM |

Detailed Education Program session descriptions, speakers, pricing, room locations and more can be found at fabtechexpo.com/edu.

WEDNESDAY, NOVEMBER 7

SCHEDULE-AT-A-GLANCE

| TECHNOLOGY | 8:00 AM - 10:00 AM | 10:30 AM - 12:30 PM | 1:30 PM - 3:30 PM | |
|---------------------------|---|---|--|----------|
| 3D/ADDITIVE MANUFACTURING | NEW! F40: A Guideline to Metal AM - Processes, Design and Applications I | F50: Business Considerations for 3D Additive Technology with Tech Tour B | NEW! F60: 3D Additive Manufacturing Applications for Fabricators I | |
| AUTOMATION | NEW! F41: Integrated Solutions for Industrial Automation I | NEW! F51: 10 Signs Your Business Needs to Replace Its ERP & Leveraging Next Gen Cloud ERP B | NEW! F61: Automated Technology Application and Benefits for Laser and Joining Process I | |
| CUTTING/LASER | AWF100: Laser Welding for Today's Fabricator Workshop I | | NEW! F62: Next Generation Cutting Technology I | |
| FINISHING | C40: Optimizing Batch Powder Coating Operations I | NEW! C50: Powder Coating and Industry 4.0, Really? A | NEW! C60: Automation - Is It for Everyone? I | |
| | NEW! C41: Blasting Your Way to Success I | C51: Identify and Solve Finishing Defects: See It, Touch It, Fix It I | NEW! C61: Safety - It Works for All of Us I | |
| | C42: Architectural Coatings - Building a Lasting Finish I | NEW! C52: Developing a Liquid Coating Knowledge Base B | NEW! C62: Improving Performance of Pretreatment Processes I | |
| FORMING & FABRICATING | NEW! F43: Sheet Metal: Controlling Costs with Good Design and Equipment Purchases I | F53: Roll Forming: Justification, Basics and Lubricants B | F63: Tube & Pipe: Forming and Lubrication A | |
| | NEW! F44: Coil Processing: Slitting Thin Materials and Laser Blanking I | F54: Effective Safeguarding Risk Assessment B | NEW! F64: Hot Forming with Titanium I | |
| LEAN | F45: Lean Tools: A3 Thinking- Developing People & Solving Problems I | F55: Lean Tools: Flow and Pull Creating Flow in High-Variety Environments I | F65: Lean Principle: Continuous Improvement in Lean Culture B | |
| MANAGEMENT | NEW! F46: Innovation & Business Strategies for Growth! I | NEW! F56: What's Your Business Worth & Patent Rights for Your IP I | F66: Succession Strategies to Protect Your Business! B | |
| MARKETING & SALES TOOLS | NEW! F47: 5 Steps to World-Class Customer Experiences B | NEW! F57: Sales & Marketing Performance Management of People and Systems I | NEW! F67: Actionable Marketing Strategies for Competitive Advantage I | |
| SMART MANUFACTURING | NEW! F48: The Human and Digital Role In The Factory of the Future I | | NEW! F68: Actionable Intelligence: Manage Data to Enable Good Decisions A | |
| STAMPING | S40: Sensor Technology - Practical Applications I | S50: Advance Press Room Technology I | NEW! S60: Sensors, Controls and Connectivity I | |
| | S41: Stamping AHSS Materials I | NEW! S51: Solving Progressive Die Problems I | S61: Preventative Maintenance in the Press Room I | |
| WELDING FABRICATION | NEW! W40: Welding of Advanced Specialty Materials I | NEW! W50: Lean & Quality Welding for Smart Manufacturing I | NEW! W60: Fundamentals of Welding Project Success I | |
| WORKFORCE DEVELOPMENT | F49: Manufacturing and the Millennial: How to Attract and Retain Emerging Leaders B | NEW! F59: Accountability, Engagement & A Culture that Rocks I | F69: Accelerating Workforce Performance Through Best Practices in Learning & Development I | |
| WELDING | | | | |
| SEMINARS | W11: The Why and How of Welding Procedure Specifications | | 8:00 AM | 5:00 PM |
| | W13: CWI Part B Hands-On Experience - Day 2 | | 8:00 AM | 5:00 PM |
| | W14: Welding of Stainless Steel - Day 2 | | 8:00 AM | 5:00 PM |
| CAREER PATH WORKSHOPS | W19: Getting Started in Underwater Welding | | 9:00 AM | 11:00 AM |
| | W21: Opportunities in Welding | | 1:00 PM | 2:30 PM |
| PROFESSIONAL PROGRAM | W24: Session 7: Plenary Session | | 8:00 AM | 9:30 AM |
| | Session 8: High Energy Density Processes | | 9:30 AM | 12:00 PM |
| | Session 9: Honorary Symposium for Dr. John Elmer - Contributions to the Welding Metallurgy of Stainless Steels | | 9:30 AM | 12:00 PM |
| | Session 10: Arc Welding | | 9:30 AM | 12:00 PM |
| | Session 11: Applied Technology | | 1:00 PM | 5:00 PM |
| | Session 12: Honorary Symposium for Dr. John Elmer - Contributions to Advanced In-Situ Characterization | | 2:00 PM | 5:00 PM |
| EDUCATIONAL SESSIONS | W28: National Center for Welding Education and Training, Weld-Ed | | 8:00 AM | 12:00 PM |
| | W22: RWMA Resistance Welding School - Day 2 | | 8:00 AM | 4:15 PM |

THURSDAY, NOVEMBER 8

SCHEDULE-AT-A-GLANCE

| TECHNOLOGY | 8:00 AM – 10:00 AM | 10:30 AM – 12:30 PM | 1:30 PM – 3:30 PM | |
|---------------------------|--|---|--|----------|
| 3D/ADDITIVE MANUFACTURING | NEW! F70: Additive Manufacturing and Hybridized Production & Workflows I | NEW! F80: 3D Additive Manufacturing Tools for Fabricators I | | |
| AUTOMATION | NEW! F71: Profitable Benefits of Automation in the Job Shop B | NEW! F81: Automation Monitoring & Maintaining Your Machines I | NEW! F91: Embracing Variability for Better Performance In Planning and Execution A | |
| CUTTING/LASER | NEW! F72: Cutting Materials, Technology & Software - Nothing Has Changed...Except Everything! B | NEW! F82: Technologies for Waterjet & Plasma Advancements & Applications I | | |
| FINISHING | NEW! C70: Top 10 Tips for Maintaining Your Powder Coating Operation I | NEW! C80: Key Elements of Spray Booth Design I | | |
| | NEW! C71: From E-Coat to Top Coat A | C81: All About Ovens I | | |
| FORMING & FABRICATING | NEW! F73: Alternate Forming Processes I | F83: Advanced Press Brake Technologies I | | |
| | F74: Roll Forming: Tooling Design and Advanced Techniques I | NEW! F84: Tube & Pipe Cutting I | | |
| LEAN | NEW! F75: Lean Tools: Advanced Lean Design and Preventative (PM) and Predictive Maintenance Strategies I | F85: Lean Tools: Lean Journey Case Studies and Lesson Learned B | | |
| MANAGEMENT | NEW! F76: Managing Innovation in 21 st Century Business I | NEW! F86: Leadership Development for Millennials B | NEW! F96: Tax Reform, Tax Credits & Bringing Manufacturing Back to America B | |
| MARKETING & SALES TOOLS | | | | |
| SMART MANUFACTURING | NEW! F78: Smart Manufacturing Supply Chain & Real-World Case Studies I | NEW! F88: Smart Manufacturing Product Development Process: Get to Market Faster B | | |
| STAMPING | NEW! S70: Sheet Metal Properties, Deformation Modes and Simulation Experiments I | NEW! S80: Stamping Process Optimization I | | |
| | S71: Transfer System Technology I | NEW! S81: Apprenticeship Program for Pressroom Technicians I | | |
| WELDING FABRICATION | | | | |
| WORKFORCE DEVELOPMENT | NEW! F79: Career-Pathing and Building Advanced Manufacturing Pipelines B | NEW! F89: Engaging, Retaining & Filling Open Positions; Do More with Less B | NEW! F99: Leverage Culture to Communicate & Deliver Breakthrough Results I | |
| WELDING | | | | |
| SEMINARS | W12: Metallurgy Applied to Everyday Welding | | 8:00 AM | 4:15 PM |
| | W15: Better Understanding of Welding Symbols | | 8:30 AM | 12:30 PM |
| PROFESSIONAL PROGRAM | W25: Session 14: Welding Metallurgy and Weldability Studies | | 8:00 AM | 10:30 AM |
| | Session 15: Honorary Symposium for Dr. John Elmer - Contributions to High Energy Density Welding | | 8:00 AM | 11:00 AM |
| | Session 16: Cladding and Dissimilar Joinings | | 8:00 AM | 10:30 AM |

EXPERIENCE LEVELS

Use this key along with the Schedule-at-a-Glance to find the education level that meets your needs.

B Basic - Recommended for the attendee who is new to the industry or needs a refresher on the topic.

I Intermediate - Designed for the attendee who already has a basic understanding of the subject matter.

A Advanced - For the attendee with several years of experience who is seeking more in-depth information.

NOV 6-8, Atlanta, GA

FABTECH

VISIT US AT
BOOTH B6329

 **MITSUBISHI LASER**



TAKE CONTROL

Introducing the NEW ADVANCED 800 eX-F Series Laser

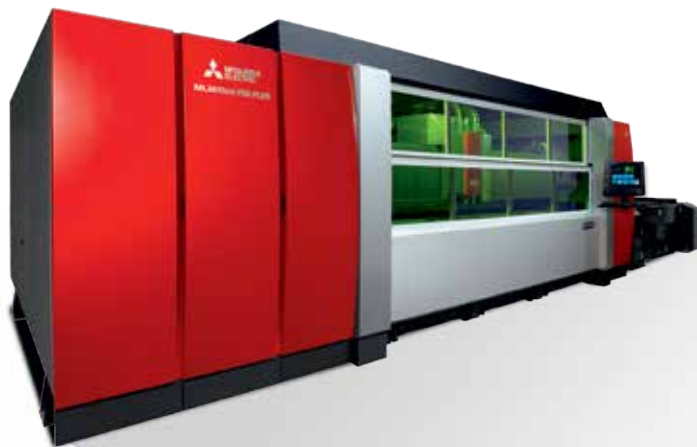

A New Level of Productivity.

Mitsubishi Laser is the fastest growing FIBER company in the industry. Find out why our **ZOOM Fiber technology** is racing to the top of the market. If you are looking for more production, less maintenance, and an overall reduction in operating cost look no further than **Mitsubishi**. Our latest **eX-F Advance 800** features the latest **Mitsubishi 800 control** which provides a 19 inch touch screen control and a *smartphone-like* user interface.

Learn more at www.mcmachinery.com

To schedule a test cut or a free machine demo,
contact us today at **630-616-5751** or visit us at www.mcmachinery.com

MC MACHINERY
SYSTEMS, INC.

a subsidiary of  Mitsubishi Corporation



NORTH AMERICA'S LARGEST METAL FORMING, FABRICATING, WELDING AND FINISHING EVENT

NOVEMBER 6 – 8

Georgia World Congress Center
Atlanta, Georgia



SAVE \$50

Register Today at
fabtechexpo.com

Use the **Promo Code** next to your address when registering online.

Fabricators & Manufacturers Association, Intl.
2135 Point Blvd | Elgin, Illinois 60123 USA

DON'T MISS THESE FUTURE FABTECH EVENTS



FABTECH Mexico
May 7-9, 2019



FABTECH Chicago
November 11-14, 2019



FABTECH Canada
June 16-18, 2020